

Appendix G, 100-W Stage and RS-232 I/O (K2/100) Rev H1, August 8, 2012



Table of Contents

Introduction	3
Customer Service Information	4
Parts Inventory.....	5
Assembly, Part I.....	12
Initial Tests.....	22
Assembly, Part II.....	27
Alignment and Installation.....	44
Using the K2/100 at High Power.....	56
Remote Control using the RS-232 Port.....	59
K2/100 Specifications	64
Troubleshooting and Repair.....	65
Circuit Details.....	69
Schematic Diagrams.....	71
Parts Placement Drawings.....	73

Introduction

Appendix G describes assembly of the K2/100 transceiver's internal 100-watt final output stage (KPA100 board). The PC board includes two conservatively-rated RF power transistors, low-pass filters, SWR bridge, monitoring circuits, speaker, and an RS-232 interface. Filter switching, T-R sequencing, and other configuration is handled by the K2/100's main microcontroller.

KPA100 assembly and installation should be done only after the transceiver has been aligned and tested at the 10-watt level.

Upgrades Recommended for Older K2s

All K2 owners are encouraged to keep their transceivers up to date by making recommended changes. These changes should be installed and tested before the KPA100 is installed.

K2 s/n 4059 or lower: K2 keying bandwidth modification (order #K2KEYMODKT). This modification is strongly recommended for CW operators, especially if you use high power. **Note:** Requires upgrade to revision 2.04 or later K2 firmware (order #FWK2MCIO).

K2 s/n 3445 or lower: PLL Upgrade (order #E850138). This ensures excellent VFO temperature stability during high-power operation.

K2 s/n 2999 or lower: (1) 10 meter band-pass filter and VFO ALC modification (#E850093, **supplied with your KPA100 kit**). (2) BFO modification (order #BFOMDKT). You should also make all applicable changes described in this document:

<http://www.elecraft.com/manual/k2a2binstr.pdf>

Pre-Wound Toroids Available

The toroids used in the KPA100 are not difficult to wind, and full instructions are provided. If you prefer not to wind them yourself, you can obtain a full set of pre-wound toroids from an Elecraft-qualified source. Ordering information can be found on our web site, www.elecraft.com. *You do not need to send your cores or wire to the winding service.*

Preparation for Assembly

With all equipment that operates at high power levels, proper assembly and alignment are critical for safe and reliable operation. Follow the instructions carefully and make all of the recommended measurements. Do not substitute components or perform any assembly steps out of order.

Please read the following information regarding tools before proceeding.

Tools Required

The following tools are required to build this kit:

- **Flush-cutters (Hakko CHP-170, Xcelite 170, etc.).** Ordinary diagonal cutters are not suitable for *flush-cutting* (trimming leads very close to the board).
- **Temperature-controlled soldering station with a fine-point, 700 to 800-degree (F) tip.** Do not use a high-wattage iron or gun with small components, since this can damage pads, traces, or the parts themselves.
- **Larger iron or soldering gun.** This will be used only for installation of power transistors, output transformer, and DC power wiring. A low-wattage iron cannot be used for these steps.
- **Digital Multimeter (DMM).** A DMM with diode-checking capability. Capacitance measurement capability is desirable, though not required.

Customer Service Information

Technical Assistance

You can send e-mail to support@elecraft.com and we will respond quickly - typically the same day Monday through Friday. Telephone assistance is available from 9 A.M. to 5 P.M. Pacific time (weekdays only) at 831-763-4211. Please use e-mail rather than calling when possible since this gives us a written record of the details of your problem and allows us to handle a larger number of requests each day.

Repair / Alignment Service (We want to make sure everyone succeeds!)

If necessary, you may return your Elecraft product to us for repair or alignment. (Note: We offer unlimited email and phone support to get your kit running, so please try that route first as we can usually help you find the problem quickly.)

IMPORTANT: You must contact Elecraft before mailing your product to obtain authorization for the return, what address to ship it to and current information on repair fees and turnaround times. (Frequently we can determine the cause of your problem and save you the trouble of shipping it back to us.) Our repair location is different from our factory location in Aptos. We will give you the address to ship your kit to at the time of repair authorization. *Packages shipped to Aptos without authorization will incur an additional shipping charge for reshipment from Aptos to our repair depot.*

To ship the unit, first seal it in a plastic bag to protect the finish. Use a sturdy packing carton with at least 3-in (8 cm) of foam or shredded paper on all sides. Seal the package with reinforced tape. (Neither Elecraft or the carrier will accept liability for damage due to improper packaging.)

Elecraft's 1-Year Limited Warranty

This warranty is effective as of the date of first consumer purchase (or if shipped from factory, date product is shipped to customer). It covers both our kits and fully assembled products. For kits, before requesting warranty service, you should fully complete the assembly, carefully following all instructions in the manual.

Who is covered: This warranty covers the original owner of the Elecraft product as disclosed to Elecraft at the time of order. Elecraft products transferred by the purchaser to a third party, either by sale, gift or other method, who is not disclosed to Elecraft at the time of original order, are not covered by this warranty. If the Elecraft product is being bought indirectly for a third party, the third party's name and address must be provided to Elecraft at time of order to insure warranty coverage.

What is covered: During the first year after date of purchase, Elecraft will replace defective or missing parts free of charge (post-paid). We will also correct any malfunction to kits or assembled units caused by defective parts and materials. Purchaser pays inbound shipping to Elecraft for warranty repair, Elecraft will pay shipping to return the repaired equipment to you by UPS ground service or equivalent to the continental USA and Canada. Alaska, Hawaii and outside U.S. and Canada actual return shipping cost paid by owner.

What is not covered: This warranty does not cover correction of kit assembly errors. It also does not cover misalignment; repair of damage caused by misuse, negligence, or builder modifications; or any performance malfunctions involving non-Elecraft accessory equipment. The use of acid-core solder, water-soluble flux solder, or any corrosive or conductive flux or solvent will void this warranty in its entirety. Also not covered is reimbursement for loss of use, inconvenience, customer assembly or alignment time, or cost of unauthorized service.

Limitation of incidental or consequential damages: This warranty does not extend to non-Elecraft equipment or components used in conjunction with our products. Any such repair or replacement is the responsibility of the customer. Elecraft will not be liable for any special, indirect, incidental or consequential damages, including but not limited to any loss of business or profits.

Parts Inventory

- Set the heat sink, shield, and painted panels aside until needed. Leave them wrapped to protect their finish.
- You should do a complete inventory (see below), which may take an hour or more. If anything is missing, contact Elecraft. Color codes and other markings are shown in parentheses. Refer to Appendix A of the owner's manual for more parts photos.





Some components in this kit can be damaged by static discharge. Before handling diodes, transistors, and ICs, touch a grounded, unpainted metal surface, or use a wrist strap.

Parts List Notes:

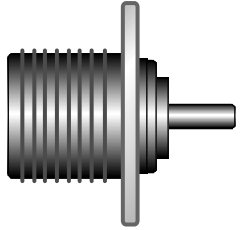
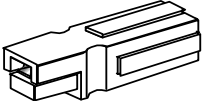
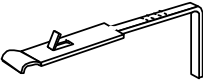
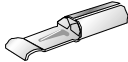
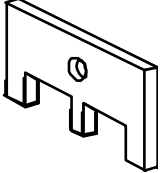

- **LS** = lead spacing in inches (metric conversions: 0.1" = 2.5 mm, 0.2" = 5 mm, 0.4" = 10 mm.)
- **In some cases, two capacitor types will have the same value but different voltage ratings or lead spacing (LS). To avoid assembly errors, you must positively identify these capacitors and keep them separate from each other. Use your DMM to verify values if possible.**
- Parts whose reference designators are shown in **bold** are for use on the K2 RF or Control boards.
- Flat-head screws are measured from the top of the head; pan head screws are measured from beneath the head.



Picture	Ref. Designator(s)	QTY	Description	Part #
	C5B	1	Cap., 18 pF ("18"), 5%, 500V or 1KV disc, 0.2" LS (may have black band)	E530088
	C3B,C4B	2	Cap., 27 pF ("27"), 5%, 500V or 1KV disc, 0.2" LS	E530089
	C5F	1	Cap., 33 pF ("33"), 5%, 500V or 1KV disc, 0.2" LS	E530090
	C3H	1	Cap., 39 pF ("39"), 5%, 500V or 1KV disc, 0.2" LS	E530091
	C5D	1	Cap., 47 pF ("47"), 5%, 500V or 1KV disc, 0.2" LS	E530092
	C4D	1	Cap., 56 pF ("56"), 5%, 500V or 1KV disc, 0.2" LS (may have black band)	E530093
	C5A,C6C	2	Cap., 68 pF ("68"), 5%, 500V or 1KV disc, 0.2" LS	E530094
	C3E,C5G	2	Cap., 82 pF ("82"), 5%, 500V or 1KV disc, 0.2" LS	E530095
	C4E	1	Cap., 120 pF ("121"), 5%, 500V or 1KV disc, 0.2" LS	E530096
	C3G,C4A,C5C,C5E,C6E	5	Cap., 150 pF ("151"), 5%, 500V or 1KV disc, 0.2" LS	E530097
	C2B,C3C,C3J	3	Cap., 220 pF ("221"), 5%, 500V or 1KV disc, 0.2" LS	E530098
	C3A,C3D,C4C,C6F	4	Cap., 270 pF ("271"), 5%, 500V or 1KV disc, 0.2" LS	E530099
	C3F,C6A,C6B,C6G	4	Cap., 330 pF ("331"), 5%, 500V or 1KV disc, 0.2" LS	E530100
	C2D	1	Cap., 390 pF ("391"), 5%, 500V or 1KV disc, 0.2" LS	E530101
	C26	1	Cap., 33 pF ("33"), 5%, 50V disc, 0.2" LS (do not confuse with C5F)	E530064
	C41,C95	2	Cap., 100 pF ("101"), 5%, 200V disc, 0.2" LS	E530034
	C66	1	Cap., 180 pF ("181"), 5%, 50V disc, 0.2" LS; voltage may not be marked	E530008

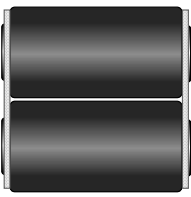
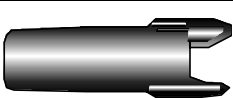

Picture	Ref. Designator(s)	QTY	Description	Part #
	C67,C80,C81,C86	4	Cap., .0047 μ F ("472"), 10%, 100V disc, 0.25" LS	E530102
	C2E,C83	2	Cap., 1000 pF ("1000"), 5%, 500V silver mica	E530085
	C2A,C6D	2	Cap., 1200 pF ("6122"), 630V polypropylene	E530033
	C2C	1	Cap., 2200 pF ("2200"), 5%, 500V silver mica	E530086
	C84	1	Cap., .001 μ F ("102"), 5%, 50V mono, 0.1" LS	E530074
	C25,C69,C70,C87, C88, CTRL-Ctxd	6	Cap., .001 μ F ("102"), 5%, 50V mono, 0.2" LS (CTRL-Ctxd may be needed for K2 Control board; see text)	E530001
	C82	0	Not used	-
	C71	1	Cap., .0018 μ F ("182"), 5%, 200V mono, 0.2" LS	E530104
	C64, C79	2	Cap., .0047 μ F ("4n7J250"), 5%, 250Vor greater , mono, 0.4" LS	E530262
	C7,C8,C9,C12-C22, C24,C28,C29,C32, C50,C65,C72,C73, C74,C76,C97-C99	27	Cap., .01 μ F ("103"), 5%, 50V mono, 0.1" LS	E530019
	C37,C38,C39,C44, C46,C68,C89,C90	8	Cap., .01 μ F ("103"), 5%, 50V mono, 0.2" LS	E530009
	C36,C42,C43,C77	4	Cap., .015 μ F ("153" or "15N"), 5%, 250V mono, 0.2" LS	E530082
	C31	1	Cap., .22 μ F ("22J63"), 5%, 63V mono, 0.2" LS	E530295
	C48,C49,C52,C53, C54,C55,C56,C57, C61,C62,C63,C85 RF-Crf	13	Cap., .047 μ F ("473"), 5%, 50V mono, 0.2" LS (RF-Crf may be needed for the K2 RF board; see text)	E530025
	C30,C33,C34,C75	4	Cap., 0.1 μ F ("104"), 20%, 50V mono, 0.1" LS	E530020
	C10,C11,C23,C35, C58,C59,C40, CTRL-C42	8	Cap., 0.1 μ F ("104"), 5%, 50V mono, 0.2" LS (CTRL-C42 may be needed for the K2 Control board; see text)	E530011
	C1,C27	2	Cap., 1-40 pF ceramic trimmer	E540002
	C60	1	Cap., 100 μ F, 16V electrolytic	E530061
	C51	1	Cap., 470 μ F, 25V electrolytic	E530084
	D1-D8	8	Diode, 1N4148	E560002
	D9	1	Diode, SB530	E560003
	D10,D13	2	Diode, 1N5404	E560010
	D11,D12,D14	3	Diode, 1N4007	E560001
	D16,D17	2	Diode, 1N5711	E560004
	E1	1	Ground terminal, right angle PCB mount, 6-32 threaded	E700012
	FAN1	1	Fan, 12 V	E980046

Picture	Ref. Designator(s)	QTY	Description	Part #
	J2	1	Connector, SO239 (Antenna)	E620064
	J3, P3	2	Connector, DC power, red housing (13.8 VDC input and mating conn., +)	E620059
	J3, P3	2	Connector, DC power, black housing (13.8 VDC input and mating conn., -)	E620060
	MISC	2	PCB pin for J3, 25 amp right angle	E620061
	MISC	2	Crimp/solder terminal for P3, 30 amps	E620062
	HDWR	2	Mounting plate for J3	E620063
	MISC	1	Spring pin, 3/32" x 1/4" (2.4 x 6.4 mm); stabilizing pin for P3	E700071
	J1,J4	2	Connector, 2p female housing, 0.156" spacing (12V and RF connectors)	E620013
	RF-P3, RF-P6	2	Mating connectors for J1 and J4, 2p male, 0.156" spacing (K2 RF board)	E620012
	HDWR	5	Crimp/solder terminal for J1 and J4, gold color (1 spare)	E620014
	J5	1	Connector, 2p female housing, 0.1" spacing (AF In)	E620021
	HDWR	3	Crimp/solder terminal for J5 (1 spare)	E620022
	J6	1	Connector, 1/8" mono jack w/switch, PCB mount (ext. speaker)	E620056
	J7	1	Connector, RCA jack, PCB mount (ext. PA key)	E620057
	J8	1	Connector, DB9F, PCB mount (RS-232 interface)	E620058
	MISC	2	Keying insert for ribbon cable connector (Shown approx. 4x actual size; may include large break-away tab)	E700065
	MISC	1	Connector, DB9M (serial I/O cable, K2 end)	E620049

Picture	Ref. Designator(s)	QTY	Description	Part #
	MISC	1	Connector, DB9F (serial I/O cable, PC end)	E620048
	MISC	2	Backshell for serial I/O cable	E620050
	K1-K12	12	Relay, SPDT, 12 V	E640011
	L1,L2,L13,L14	4	Toroidal ind., T50-2 core (iron powder, red, 0.5" dia.)	E680005
	L4-L8,L10-L12	8	Toroidal ind., T50-10 core (iron powder, black, 0.5" dia.) Note: One FT50-43 gray ferrite core, also 0.5" dia., is supplied (see T4). The T50-10 iron power cores have a shiny, black finish, while the ferrite core is dull gray. <i>Label the ferrite core to avoid confusing it with the eight iron powder cores.</i>	E680016
	L16, RFC1	2	Toroidal ind., T50-1 core (iron powder, blue, 0.5" dia.)	E680001
	L18	0	Jumper (see text)	n/a
	P1	1	Connector, 10 pin dual row (5 x 2), 0.1" spacing	E620040
	Q1,Q2	1	Matched set of (2) 2SC2879 transistors	E850123
	Q3,Q4	2	Transistor, NPN, MJE182, TO-225AA package	E580016
	Q5,Q8	2	Transistor, NPN, 2N3904, TO-92	E580017
	Q6,Q7	2	Transistor, MOSFET, 200 V, ZVN4424, TO-92	E580005
	Q10,Q11,Q12	3	Transistor, MOSFET, 60 V, 2N7000, TO-92	E580002
	Q9	1	Transistor, HEXFET, 500 V, IRF830 or IRL620, TO-220 (tab may be cut)	E580018
	R2,R3	2	Resistor, 2.7 ohms, 5%, 1/4 W (RED-VIO-GOLD)	E500055
	R9	1	Resistor, 10 ohms, 5%, 1/4 W (BRN-BLK-BLK)	E500054
	R10	1	Resistor, 47, 5%, 1/4 W (YEL-VIO-BLK)	E500019
	R33	1	Resistor, 1000 ohms, 5%, 1/4W (BRN-BLK-RED)	E500013
	R1,R29,R15,R16	4	Resistor, 3.3 k, 5%, 1/4 W (ORG-ORG-RED)	E500017
	R8	1	Resistor, 10 k, 5%, 1/4 W (BRN-BLK-ORG)	E500015
	R5	1	Resistor, 15 k, 5%, 1/4 W (BRN-GRN-ORG)	E500060
	R4	1	Resistor, 100k, 5%, 1/4W (BRN-BLK-YEL)	E500006
	R11	1	Resistor, 510 k, 5%, 1/4W (GRN-BRN-YEL)	E500069
	R32	1	Resistor, 100 ohms, 1%, 1/4W (BRN-BLK-BLK-BLK) Note: Don't confuse R32 with 100- μ H RF choke RFC3. RF chokes can be identified by their much lower DC resistance (typically 1 to 8 ohms).	E500059
	R30	1	Resistor, 3.09 k, 1%, 1/4W (ORG-BLK-WHT-BRN)	E500072
	R24,R25	2	Resistor, 8.45 k, 1%, 1/4W (GRY-YEL-GRN-BRN)	E500071
	R28,R31	2	Resistor, 200 ohms, 5%, 1W (RED-BLK-BRN) or (201J)	E500074
	R40	1	Resistor, 22K, 5%, 1/4W (RED-RED-ORG)	E500090
	R23	0	Resistor, 0 ohms (jumper); see text	n/a
	R14	1	Resistor, 470 ohms, 5%, 1W (YEL-VIO-BRN)	E500075
	R19,R20	2	Resistor, 1.6 ohms, 5%, 2W	E500177
	R21,R34,R35	3	Resistor, 10 ohms, 5%, 2W	E500077

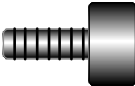
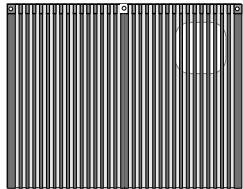
Picture	Ref. Designator(s)	QTY	Description	Part #
	R38,R39	2	Resistor, 22 ohms, 5%, 3W	E500128
	R22	1	Resistor, 300 ohms, 5%, 2W	E500129
	R13	1	Resistor, 100 ohms, 5%, 3W	E500080
	R7	1	Resistor, .005 ohms, 1%, 3W (current sensing)	E500079
	R6	1	Potentiometer, 1K trimmer ("102"), bias set	E520010
	R26,R27	2	Potentiometer, 100K trimmer ("104"), SWR set	E520001
	RFC3,RFC11	2	RF Choke, 100 μ H (BRN-BLK-BRN), 0.4" LS	E690016
	RFC4, RFC5, RFC9	3	RF Choke, 15 μ H (BRN-GRN-BLK), 0.4" LS	E690006
	RFC6,RFC7,RFC8	3	RF Choke, 100 μ H, miniature (BRN-BLK-BRN), 0.2" LS	E680013
	RP1	1	Resistor network, 3.9 k, 8 pins (marked part number should include "392")	E510000
	SP1	1	Speaker, 4 ohms, 3W	E980007
	T1	1	Transformer, small binocular toroid core (gray, approx. 0.5" x 0.75")	E680014
	T2	1	Transformer, large binocular toroid core (gray, approx. 1" x 1.2")	E680015
	T3	1	Transformer, FT37-61 toroidal core (gray, 0.37" dia.)	E680002
	T4	1	Transformer, FT50-43 toroidal core (gray, 0.5" dia.)	E680008
	U1	1	IC, PIC16F872 microcontroller, pre-programmed, KPA100	E610011
	MISC	1	Socket for U1, 28 pins	E620011
	U2	1	IC, octal peripheral driver, TD62083AP (alt: ULN2803)	E600040
	U3	1	IC, 5-volt regulator, 78L05	E600029
	U4	1	IC, RS-232 driver/receiver, MAX1406CPE (alt: LT1039CN16)	E600036
	U5	1	IC, dual op-amp, LM358AN	E600010
	U6	1	IC, high-current op-amp w/enable, EL5146CN	E600041
	U7	1	IC, dual op-amp, rail-to-rail, LMC6482AIN	E600011
	X1	1	Crystal, 18.432 MHz, low profile ("S184ECSL")	E660019
	X2	1	Crystal, 4 MHz ("4.00-20")	E660006
	Z1	2	Ferrite beads, 0.23" (6 mm) long; two beads on a 1N4007 diode lead	E980029
	HDWR	2	Fuse holder housing, twist-lock (for external 20A fuse)	E980047
	HDWR	2	Fuse holder contacts, #12 size	E980048
	HDWR	1	Fuse holder spring, for 1.25" long fuse	E980049

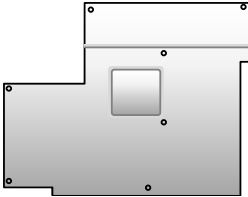
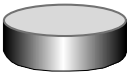
Picture	Ref. Designator(s)	QTY	Description	Part #
	HDWR	2	Fuse, 20A, Littlefuse #312020 or equivalent (1 spare)	E980050
	HDWR	2	Jackscrew, 4-40, hex (for J8)	E700078
	HDWR	5	Standoff, 3/16 dia. x 3/16" long hex 4-40 thd (between PCB and heat sink)	E700068
	HDWR	2	Standoff, 3/16 dia. x 1/2" long hex 4-40 thd (between PCB and shield)	E700061
	HDWR	5	Standoff, 3/16 dia. x 5/8" long hex 4-40 thd (between PCB and shield)	E700060
	HDWR	20	Screw, 4-40 x 3/16" pan head, black oxide (2 spares)	E700015
	HDWR	5	Screw, 4-40 x 3/16" undercut flathead, black oxide (1 spare)	E700025
	HDWR	19	Screw, 4-40 x 1/4" panhead (2 spares)	E700005
	HDWR	3	Screw, 4-40 x 1/4" flathead (1 spare)	E700063
	HDWR	5	Screw, 4-40 x 11/16" flathead	E700199
	HDWR	8	Set screw, 4-40 x 1/2", .05" hex socket head, stainless steel (1 spare)	E700066
	HDWR	15	Nut, 4-40 small pattern (2 spares)	E700055
	HDWR	1	Nut, 6-32 hex, stainless steel (for GND screw)	E700069
	HDWR	36	Lock washer, #4 split (3 spares)	E700004
	HDWR	2	Flat washer, #6, Stainless Steel	E700067
	HDWR	3	Spring clip (used on shield) Note: Illustration at left shows side and front views of clip.	E980058
	HDWR	3	Solder lug (used for grounding J2)	E700062
	HDWR	1	Thumbscrew, 6-32 x 1/2", black plastic knob (for GND screw, E1)	E700070
	HDWR	5	Fiber washer for speaker, #4, .047" thick x 0.25" dia. (1 spare)	E700028
	MISC	1	Heat sink, KPA100, approx. 7.6" W x 6" L (19.23 x 15.2 cm)	E100127
	MISC	1	PC board, KPA100	E100134
	MISC	1	Top cover trim panel, KPA100, painted (wrapped in paper)	E100135
	MISC	1	Rear panel, KPA100, painted and silk-screened (wrapped in paper)	E100136

Picture	Ref. Designator(s)	QTY	Description	Part #
	MISC	1	Shield, KPA100, approx. 7.3" W x 6" L (18.5 x 15.2 cm)	E100137
	MISC	1	Speaker shield, 1.9" diameter (4.8 cm), with self-adhesive pad on inside	E980087
	MISC	1	Grille cloth, black, approx. 3 x 3" (7.5 x 7.5 cm)	E980053
	MISC	2	Thermal pad for flange-mount power transistor (Q1 and Q2)	E980051
	MISC	2	TO-126 thermal pad, self-adhesive (Q3, Q4)	E980052
	MISC	1	BNC connector cap, plastic (to cap K2's BNC antenna jack)	E980006
	MISC	26 ft.	Enamel wire, #22 red (for all low pass filter toroids)	E760018
	MISC	9 ft.	Enamel wire, #26 red (for T3, T4, L16)	E760002
	MISC	3 ft.	Enamel wire, #26 green (for T3 and T4)	E760004
	MISC	5 ft.	2-conductor wire, #12 stranded, red/black (for DC power wiring)	E760033
	MISC	1 ft.	RG174 coax (for RF cable to K2 RF board)	E760010
	MISC	1	10-conductor ribbon cable with pre-installed connectors; 4" long	E980045
	MISC	1 ft.	2-conductor speaker cable, #24 stranded (for J5 and speaker)	E760012
	MISC	10 ft.	4-conductor shielded cable (serial I/O cable)	E760009
	MISC	1 ft.	Stranded insulated hookup wire, #20 black (for DC cable to K2 RF board)	E760006
	MISC	1 ft.	Stranded insulated hookup wire, #20 red (for DC cable to K2 RF board)	E760007
	MISC	1 ft.	Hookup wire, #24, solid conductor, green ins. (for K2 Control board mod)	E760008
	MISC	1 ft.	Stranded, Teflon-insulated wire, #22 gray (for T1)	E760020
	MISC	2 ft.	Stranded, Teflon-insulated wire, #18 gray (for T2)	E760021
	MISC	3	Cable tie, 3"	E980002
	MISC	1	Allen wrench, .05", short handled (for 1/2" heat sink set screws)	E980008
	MISC	1	Sand paper, 180-grit (for heat sink preparation)	E850090

Assembly, Part I

Place the KPA100 PC board as shown in Figure 1, and identify the top side, which has most of the components. (A complete parts placement drawing can be found at the end of this appendix.) The "Front Edge" and "Back Edge" designations are based on the board's orientation when installed in the K2.

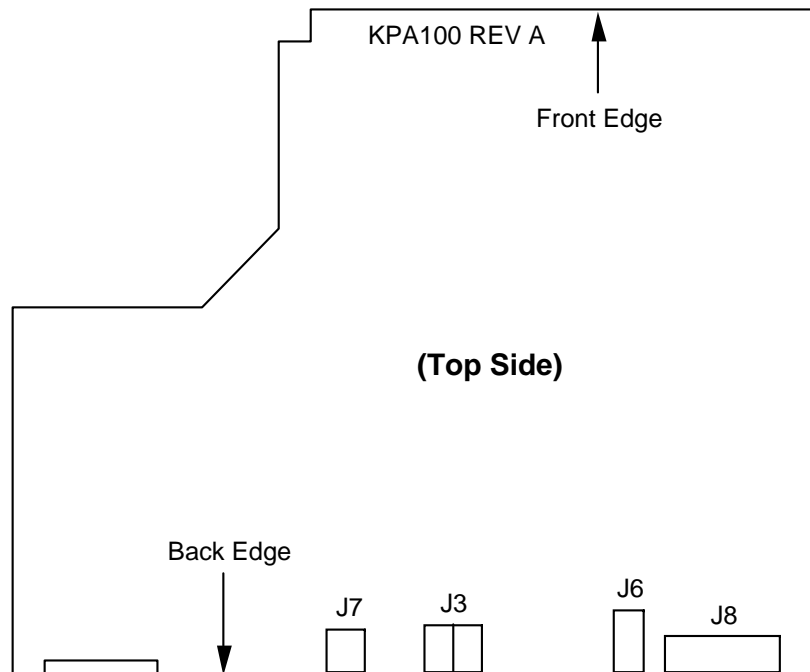

Figure 1

With the **bottom** side of the board facing you (speaker cutout at the upper right), locate the position for resistor R28, along the back edge, far right. The label "R28" is just above of the resistor's outline.

Install a 200-ohm, 1-watt resistor (red-black-brown) or (201J) at R28. Form the leads to fit the given pad spacing. Bend the leads to hold the resistor in place. **Note:** It's a good idea to orient all resistors in one direction for ease in reading the color codes later. If R28 has color bands, orient it with the first color band (red) toward the left.

Make sure R28 is seated flat on the board, with no excess lead length exposed. This is necessary to keep the resistor from touching the heat sink, which will be attached later.



The use of acid-core solder, water-soluble flux solder, or any corrosive or conductive flux or solvent will void your K2's warranty. Also avoid "No-Clean" solder types, which may make board re-work more difficult. We recommend the use of Kester type 44 rosin core solder or similar. The residue from such solder need not be removed, since it is non-conductive. The use of cleaning solvents may damage the board or components.

Solder R28 from the **top** side of the board. Do not use an excessive amount of solder. Trim the leads to about 1/16" (1.5 mm) or shorter.



If your solder joints are not clean and shiny, your iron may not be hot enough, or you may be using the wrong type of solder. These "cold" solder joints will likely result in poor performance, reliability problems, or component failure. Before proceeding, consult our web site for additional soldering instructions and tool recommendations.

On the **top** side of the board, locate the component outline for .005-ohm current-sensing resistor R7 (near the DC power connector, J3). Each of R7's pads has three holes.

Bend the leads of the .005-ohm, 3-watt resistor to match the spacing between R7's innermost pair of holes (see Figure 2a). Install the resistor, pressing it down onto the board as far as it will go.

On the bottom side, fold R7's leads outward so they lay flat against the pads (Figure 2b). Trim the leads to match the size of the pads. Solder each lead over the full length of the pad.

Note: Components may be soldered one at a time or in groups. Leads can be trimmed either before or after soldering. *Flush trimming* (trimming very close to the board) is required only when specified. Otherwise, trim leads to about 1/16" [1.5 mm] or less in length.

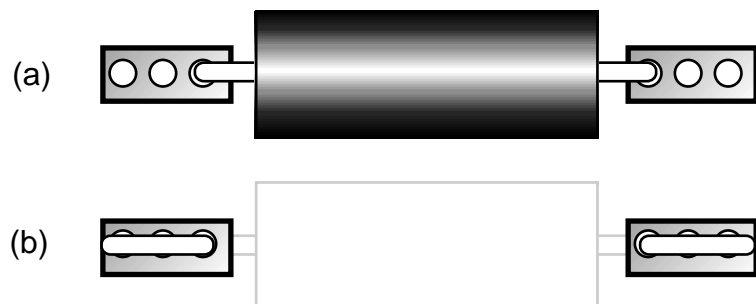



Figure 2

 **The leads on small capacitors are fragile. Do not pull on the leads or bend them excessively.**

Sort all capacitors into groups by capacitance value. Start by grouping them by physical appearance (size, color, etc.).

In all cases where two or more capacitor types have the same value, further sort them by lead spacing and voltage rating. The parts list provides identification details for specific capacitor types.

Locate an **0.1- μF** ("104") capacitor with **0.1" lead spacing** for use at C75.

Install C75 at its indicated location on the **bottom** of the board, near the back edge. The capacitor must be seated as close to the board as possible, with 1/16" (3 mm) or less lead length exposed. Remove any U-shaped bends or folds using long-nose pliers. Solder C75 from the top side of the board.

Install a **.01- μF** ("103") capacitor with **0.1" lead spacing** at C65. C65 is located on the **bottom** side of the board, near the front edge. Keep the lead length short, as described in the previous step.

The color bands on 1/4-watt 1% resistors can be difficult to read. Use a DMM (digital multimeter) to verify the values of all these resistors. Tape them to a piece of paper with their values labeled.

Install the resistors listed below on the **top** side of the board. Start with R3, which is at the front edge of the board, near the "KPA100" label.

In general, assembly proceeds from left to right and from front edge to back edge on the PC board.

- __ R3, 2.7 ohms, 1/4 W (red-violet-gold)
- __ R24 and __ R25, 8.45 k, 1%, 1/4 W (gray-yellow-green-brown)
- __ R15 and __ R16, 3.3 k, 1/4 W (orange-orange-red)
- __ R31, 200 ohms, 1 W (red-black-brown) or (201J)
- __ R4, 100 k, 1/4 W (brown-black-yellow)
- __ R10, 47 ohms, 1/4 W (yellow-violet-black)
- __ R5, 15 k, 1/4 W (brown-green-orange)
- __ R8, 10 k, 1/4 W (brown-black-orange)
- __ R30, 3.09 k, 1% (orange-black-white-brown)
- __ R32, 100 ohms, 1%, 1/4 W (brown-black-black-black)

- __ R14, 470 ohms, 1 W (YEL-VIO-BRN) (**located near back edge**)
- __ R11, 510 k, 1/4 W (green-brown-yellow)
- __ R13, 100 ohms, **3 watts**
- __ R1, 3.3 k, 1/4 W (orange-orange-red)
- __ R2, 2.7 ohms, 1/4 W (red-violet-gold)
- __ R29, 3.3 k, 1/4 W (orange-orange-red), location: far left, near small notch

Sort all of the RF chokes by size and value. Do not pull on the leads, which are fragile and can be easily damaged.

Locate a small 100- μ H RF choke for use at RFC11 (BRN-BLK-BRN color code, 0.4" lead spacing). Do not use one of the miniature 100- μ H RF chokes, which has a much smaller lead spacing.

Install RFC11 on the **bottom** side of the board. Its location is close to the cutout for power transistor Q1.

Make sure RFC11 is pressed against the board as far as it will go, then solder it from the top side of the board.

Install and solder the RF chokes listed below. Limit soldering time on miniature chokes (2 to 3 seconds per lead). All chokes are on the top side of the board near connectors J3 and J8. The body of RFC9 is slightly longer than the spacing of the solder pads on the board. Bend the leads under the body of RFC9 as needed to pass through the pads. RFC9 will stand slightly above the board. That is normal.

- __ RFC9, 15 μ H, miniature (brown-green-black)
- __ RFC6, __ RFC7, __ RFC8, 100 μ H, miniature (brown-black-brown)
- __ RFC4, __ RFC5, 15 μ H, small (brown-green-black)

Locate miniature choke RFC3, 100 μ H (brown-black-brown) and resistor R33, 1k, 1/4 watt (brown-black-red).

Bend the leads of RFC3 to fit the pads on the board, but do not install it yet.

Mount resistor R33 on top of choke RFC3 as shown in Figure 3. Wrap each resistor lead around the RFC lead next to its body once and solder. Keep the soldering time short to avoid damaging the choke.

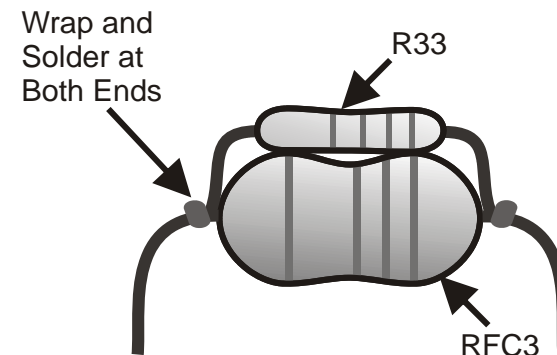

Figure 3

Install the R33/RFC3 pair in the location marked RFC3 with the choke against the board and the resistor above it. Solder and trim the leads.

Check the resistance across each RF choke using the lowest resistance scale of your DMM. This will ensure that the chokes were not damaged during soldering. All readings should be under 10 ohms.

Sort all of the diodes according to type. Use a magnifying glass if necessary to positively identify glass diodes (1N4148 and 1N5711).

Install diodes D1-D8 (1N4148) on the **bottom** side of the board, near the large cutout, but do not solder yet. Bend the leads very close to the body to fit the given pad spacing. The banded end of each diode (cathode) must be aligned with the band on its component outline.

Make sure D1-D8 are seated as far down on the PC board as possible. Solder and trim the leads.

 **When installing the diodes in the next step, save the trimmed 1N4007 leads in a small labeled bag for use as jumpers, etc., in later steps.**

Install the remaining diodes on the **top** side of the board. Start with D17, at the lower left-hand corner near the small notch.

__ D17, 1N5711 __ D16, 1N5711
__ D10, 1N5404 __ D13, 1N5404

Note: D14, 12, and 11 are *not* all oriented in the same direction

__ D14, 1N4007 __ D12, 1N4007 __ D11, 1N4007
__ D9, SB530

Using the diode check scale on your DMM, test all of the diodes on the board. (This will ensure that diodes have not been damaged during installation.) First, touch the red (+) lead of the DMM to the anode (non-banded end), and the black (-) lead to the cathode (banded end); the meter should indicate a forward voltage in the range of 0.1 to 0.7 volts, varying with diode type. Next, reverse the leads; the DMM should show an open-circuit indication (flashing "3.000" or "0.000," etc.).

Near the "ELECRAFT" label, you'll find a short jumper location, identified by a ground symbol (\perp). Use a saved 1N4007 diode lead to make a 3/4" (19 mm) U-shaped wire for this jumper. Mount the jumper on the top side of the board, with the top of the U-shape approx. 1/4" (6 mm) above the board. Solder it from the bottom side.

Install the following capacitors on the **bottom** side of the PC board, but **do not solder yet**. Capacitors must be seated as close to the board as possible. About 1/16" (3 mm) of lead length may remain exposed. Remove any U-shaped bends or folds using long-nose pliers.

Note: These capacitors are all **.01 μ F (103)**, with **0.1"** lead spacing.

__ C99 \Rightarrow __ C97 \Rightarrow __ C98 \Rightarrow __ C22
__ C74 __ C29 __ C13 __ C15
__ C17 __ C19 __ C21 __ C14
__ C16 __ C18 __ C20

Use a ruler to check the height of all capacitors just installed, as well as C65 (near the front edge) and C75 (near the back edge). If any capacitor body extends to 3/16" (4.5 mm) or more above the surface of the board, fold it down toward the board. The capacitors should not touch any adjacent pads.

Solder the capacitors from the top side. **Use just enough solder to fill the hole, since the leads will be flush-trimmed in the next step.**

 **Important:** Relays K1-K12 will be installed on the top side of the board, opposite capacitors C13-C22 and C29. This requires that the capacitor leads and their surrounding solder fillets be trimmed as close to the PC board as possible.

Flush-trim the leads of C13-C22 and C29 on the top side of the board. After trimming, the leads and surrounding solder fillets should be no more than 1/32" (0.8 mm) high.

Install the **0.2" lead spacing** capacitors listed below on the **top** side of the board. Start with C11, which is along the front edge of the board near the "KPA100" label.

__ C11, 0.1 μ F (104) __ C23, 0.1 μ F (104) __ C25, .001 μ F (102)

__ C68, .01 μ F (103) __ C89, .01 μ F (103)

__ C26, 33 pF, **50V** (Do not confuse with C5F, rated at **500 V or 1 KV**)

__ C41, 100 pF (101)

__ C38, .01 μ F (103)

__ C39, .01 μ F (103)

__ C37, .01 μ F (103)

__ C36, 0.015 μ F (153, 15N)

__ C35, 0.1 μ F (104)

__ C44, .01 μ F (103)

__ C42, 0.015 μ F (153, 15N)

__ C43, 0.015 μ F (153, 15N)

__ C46, .01 μ F (103)

__ C40, 0.1 μ F (104)

Place relays at locations K1-K12, *excluding K3*. (K3 will be installed after the output transformer, T2.) Each relay can only be installed one way; the white mark on the relay must be oriented as indicated by the mark on the component outline. **Do not solder the relays yet, and do not clip or bend the relay leads.**

Inspect each relay to make sure that it is seated flat against the board. If not, remove it and flush-trim the leads which are preventing it from sitting flat against the board.

Make sure that you have **not** installed relay K3.

Using a hardcover book or other flat object to hold the relays in place on the top side of the board, flip the board over. Solder two diagonal corner pins on each relay.

Inspect the 11 relays closely to make sure that they're seated flat against the PC board. If not, re-heat the corner pins one a time while pressing down on the relay. Once all relays are properly seated, solder the remaining pins. **Do not trim relay leads, which can cause mechanical stress, reducing the life of the relay.**

Install resistor network RP1 near the "KPA100" label at the front edge of the board. The dotted (pin 1) end of RP1 should be oriented to the left. (RP1 is symmetrical and can be reversed, but this orientation will help visually identify the pin 1 end.)

Install trimmer potentiometers R26 and R27 (100 k, "104") near the speaker cutout. The trimmers will sit a small distance above the PC board on the pin shoulders. Set the trimmers to their midpoints.

Install trimmer potentiometer R6 (1 k, "102") at the right side of the board near T1. Set the trimmer fully counter-clockwise.

Install the 1 to 40 pF ceramic trimmer capacitors, C1 and C27. C1 is at the far left near the small notch. C27 is near the microcontroller, U1 (16F872). Orient the flat side of each trimmer as indicated. Some trimmers are more triangular in shape. Orient them as follows:



FLAT SIDE

Using a small flat-blade screwdriver, set both trimmers to their midpoints (screwdriver slot perpendicular to the flat side as shown above).

Install the small capacitors listed below. (The first capacitor in the list, C50, is near trimmer C27). **Lead spacing (LS) and voltage are shown where required to identify the capacitor type.**

- | | |
|---|---|
| __ C50, .01 μ F (103), 0.1" LS | __ C30, 0.1 μ F (104), 0.1" LS |
| __ C33, 0.1 μ F (104), 0.1" LS | __ C34, 0.1 μ F (104), 0.1" LS |
| __ C61, .047 μ F (473) | __ C62, .047 μ F (473) |
| __ C63, .047 μ F (473) | __ C70, .001 μ F (102), 0.2" LS |
| __ C69, .001 μ F (102), 0.2" LS | __ C55, .047 μ F (473) |
| __ C56, .047 μ F (473) | __ C57, .047 μ F (473) |
| __ C54, .047 μ F (473) | __ C53, .047 μ F (473) |
| __ C52, .047 μ F (473) | __ C49, .047 μ F (473) |
| __ C48, .047 μ F (473) | __ C31, .22 μ F (μ 22J63) |
| __ C86, .0047 μ F (472) 0.2" LS | __ C76, .01 μ F (103), 0.1" LS |
| __ C67, .0047 μ F (472) 0.2" LS | __ C77, .015 μ F (153, 15N) |
| __ C66, 180 pF (181) | |
| __ C28 .01 μ F (103), 0.1" LS (far left side of the board near K4) | |
| __ C12, .01 μ F (103), 0.1" LS | |
| __ C95, 100 pF (101) (near small notch and T4) | |
| __ C88, .001 μ F (102), 0.2" LS | __ C87, .001 μ F (102), 0.2" LS |
| __ C24, .01 μ F (103), 0.1" LS | __ C85, .047 μ F (473) |
| __ C90, .01 μ F (103), 0.2" LS | __ C71, .0018 μ F (182), 0.2" LS |
| __ C72, .01 μ F (103), 0.1" LS | __ C73, .01 μ F (103), 0.1" LS |
| __ C10, 0.1 μ F (104), 0.2" LS | __ C32, .01 μ F (103), 0.1" LS |
| __ C7, .01 μ F (103), 0.1" LS | __ C8, .01 μ F (103), 0.1" LS |
| __ C9, .01 μ F (103), 0.1" LS | __ C84, .001 μ F (102), 0.1" LS |

Install the low-pass filter capacitors listed below. All are 500 V or 1KV (1000 V) disc, with 0.2" lead spacing. These capacitors are located on the left side of the board between the two rows of relays (K3-K12).

Note: Some of these capacitors are arranged in close-spaced groups of three on the board. **Look at all of the reference designators in a group to be sure you know which capacitors they refer to.**

- __ C5B, 18 pF (may have black band on top and no marked voltage)
- __ C3B, and __ C4B, 27 pF
- __ C5F, 33 pF (Do not confuse with C26, which is 33 pF, 50 volts)
- __ C3H, 39 pF
- __ C5D, 47 pF
- __ C4D, 56 pF (may have black band on top and no marked voltage)
- __ C5A, 68 pF
- __ C6C, 68 pF (Note: C6D pertains to the large cap to the left of C6C)
- __ C3E, and __ C5G, 82 pF
- __ C4E, 120 pF (121)
- __ C3G, __ C4A, __ C5C, __ C5E, and __ C6E, 150 pF (151)
- __ C2B, __ C3C, and __ C3J, 220 pF (221)
- __ C3A, __ C3D, __ C4C, and __ C6F, 270 pF (271)
- __ C3F, __ C6A, __ C6B, and __ C6G, 330 pF (331)
- __ C2D, 390 pF (391)

Install a .0047 μ F capacitor, C79 (0.4" lead spacing, "4n7J250"). C79 is located near relay K2.

Install a .0047 μ F ("4n7J250") capacitor with 0.4" lead spacing at C64. C64 is located near relay K2.

Install the electrolytic capacitors, C51 and C60. **C51 (470 μ F)** is near the large transformer, T2. **C60 (100 μ F)** is near T1. The (+) lead must be installed in the hole marked with a "+". The (+) lead is usually longer than the (-) lead, and the (-) lead is identified by a black or white stripe.

Install the low-profile 18.432 MHz crystal ("S184ECSL") at X1, near the speaker cutout. Make sure the crystal is seated flat against the board, then solder. Use a minimum amount of solder to avoid a short under the can. **Note:** Insulators are not needed for crystals. The solder mask on the top of the board provides adequate insulation.

Install the 4 MHz crystal (X2) near the microcontroller (U1). Use minimal solder. Excess solder may short the lead to the case under the crystal. **X2 must be seated flat against the board, with no insulators or other spacers under it, or the metal shield will not fit correctly.**

Cut two 3/4" (19 mm) bare wires (use small component leads).

Insert a bare wire into the grounding hole provided just to the left of X2. **Solder this wire to the side of the crystal can, not the top, or it will prevent installation of the shield in a later step.** Keep soldering time below 5 seconds; if it takes longer, your iron may not be hot enough, or your iron tip may not be making good contact with the crystal can.

Turn the board over, then solder and trim X2's ground wire.

Ground crystal X1 using the second bare wire. X1 is low profile, so the wire can be soldered to the top of the can. Avoid overheating. It may help to pre-tin the crystal can before attaching the ground wire.

Install the 10-pin, dual-row (5x2) male connector at P1, but do not solder yet. Figure 4 shows P1 as viewed from right side of the board. The plastic part of the connector must be on the **top** side of the board, with the long end of the pins pointed up. The short ends are inserted into the board.

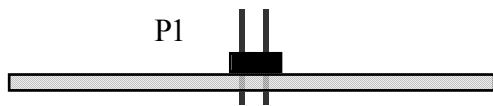

Figure 4

Solder just one pin of P1, from the bottom side. **Note:** P1's plastic body can melt if too much heat is applied, causing the pins to be mispositioned. Limit soldering time to 2 to 3 seconds.

Examine the placement of P1. If it is not flat against the board, re-heat the soldered pin while pressing down on the connector.

Once P1 is in the right position, solder the remaining pins. Do not trim the leads.

Install a 2N3904 transistor at Q8, near X1. (Use a magnifying glass if necessary to identify TO-92 package transistors.) The flat side of the transistor must be oriented toward the flat side of its outline as shown in Figure 5a.

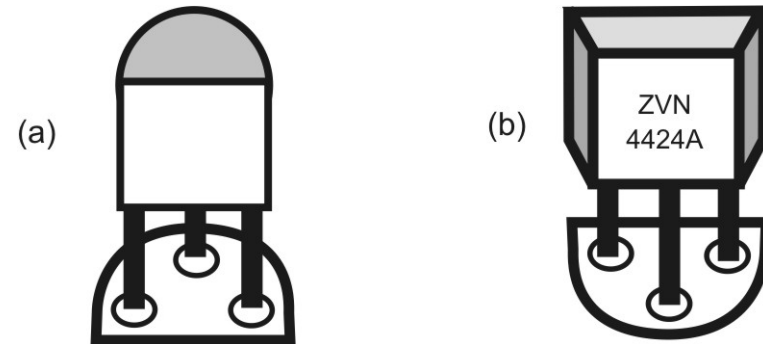

Figure 5

Install another 2N3904 at Q5, which is on the right side of the board near potentiometer R6 (labeled "BIAS SET").

Install voltage regulator U3 (78L05), which has a 3-lead TO-92 package like the 2N3904 transistor. U3 is located in the right-front corner of the board near connector P1.



The MOSFET transistors to be installed in the following steps can be easily damaged by static discharge. Before and during installation of these devices, touch an unpainted, grounded metal surface.

Install MOSFET transistors Q10, Q11, Q12 (2N7000), which are located near the "KPA100" label. The flat side of each transistor must be aligned with the flat side of its outline as shown in Figure 5a.

MOSFET transistors Q6 and Q7 (ZVN4424) have a modified TO-92 package that must be oriented as shown in Figure 5b. Some ZVN4424's may be labeled on both sides, so you'll need to go by the *shape* of the part: orient the larger flat side toward the flat side of the outline. Install and solder Q6 and Q7, which are located between relays K1 and K2.

Q9 is a TO-220 package MOSFET (IRF830 or IRL620) with a metal tab. The tab may have been cut off already. If not, you'll need to trim it. Using heavy wire cutters or tin snips, cut off most of the tab (see Figure 6). This is necessary to prevent the tab from shorting to the shield in later steps. **Do not use flush cutters or other small cutting tools to cut off the tab; this may damage the tool.**

Install Q9 vertically as shown below. The transistor will sit above the board due to the shoulders on the leads. **The tab must be oriented toward J7 as indicated by the component outline.** Trim the pins on the bottom after soldering.

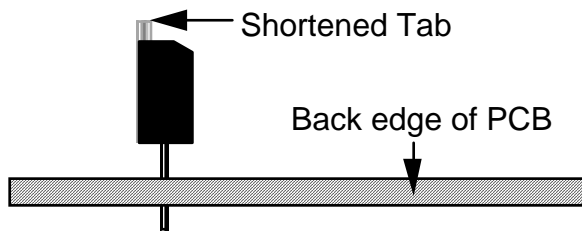

Figure 6

Transistor Q3 (MJE182) will be installed on the **bottom** side of the board, near the board cutout for power transistor Q2. Place the transistor over its outline, **with the metal side of the package facing away from the board**. Bend the three leads at right angles to match the given pad locations, but do not solder yet. **Note: the leads will break if bent too many times.**

Insert Q3's leads into their holes. Center the transistor's plastic body within its component outline. Re-form the leads if necessary.

Verify that Q3's metal side is facing away from the board, then solder the leads from the **top** side, keeping the transistor pressed down against the board.

Install Q4 in the same manner.

Locate R40, a 22K 1/4 W resistor (red-red-orange).

Make a 1/4" (6.3 mm) length of insulation by stripping a short segment from one end of the red or black #20 insulated wire. Don't use the green #22. That insulation is too small.

Slide the insulation over one lead of R40 and position it against the body of the resistor.

Mount R40 on the bottom of the PCB as shown in Figure 7. There is no outline on the board for this resistor. Study the traces carefully to be sure you have it positioned correctly. Position the resistor against the board. The insulation is to ensure the bare lead cannot short to any of the traces. If necessary trim the insulation slightly if it is too long. Solder to the existing solder pads that are already occupied by leads. Trim the resistor leads short so no excess lead extends beyond the solder.

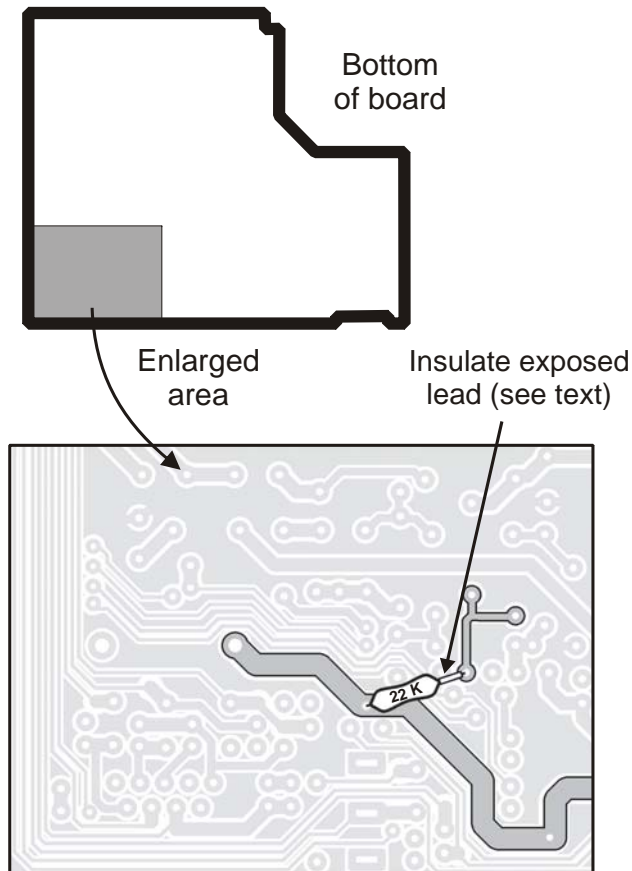



Figure 7

 **Before handling ICs, touch a metal surface. ICs damaged by electrostatic discharge can become intermittent, and the resulting problems may be difficult to troubleshoot.**

Note: The pin 1 end of ICs can be identified by a notch or dimple as shown in Figure 8. This end must be oriented toward the notched end of the component outline.

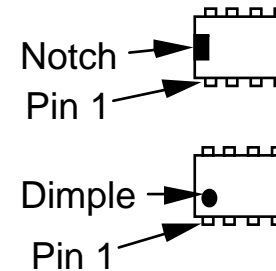

Figure 8

Install U5 (LM358, 8 pins), which is located on the top side of the board, left of the "KPA100" label. A portion of the part number is printed on the board under the IC ("358"). **Do not solder yet.**

Bend two opposite corner pins on the bottom side to hold the IC in place. Solder all 8 pins (about 1 to 2 seconds per pin).

Install the ICs listed below. All are located to the right of U5. Compare the part number on the IC to the number printed on the board, and make sure that the pin 1 end is oriented correctly.

- | | |
|--------------------------------------|--------------------------------------|
| <input type="checkbox"/> U2, TD62083 | <input type="checkbox"/> U6, EL5146 |
| <input type="checkbox"/> U4, MAX1406 | <input type="checkbox"/> U7, LMC6482 |

Install the 28-pin IC socket at U1. The notched end of the socket must be aligned with the notched end of its outline.



In the following steps you'll be installing several connectors at the back edge of the PC board (top side). These connectors must be installed correctly in order for the rear panel to fit onto the PC board. Figure 33 (page 41) shows how the rear-panel connectors will appear once installed.

- Install the external speaker jack, J6, at the back edge of the board. **Solder the center pin only.** Make sure that the jack is pressed down flat against the board while soldering.
- If J6 does not appear to be aligned with its PC board outline, or it is tilted, re-heat the center pin while adjusting the connector's position. Once it is positioned correctly, solder the other two pins.
- Locate screw terminal E1. If it was supplied with a screw, remove it. The screw will not be used.
- Place E1 in its indicated position, with the threaded hole facing the rear edge of the board. **Solder just one pin.** CAUTION: This part will get hot; don't touch it with your finger while soldering.
- If necessary, reheat the soldered pin of E1 and adjust it so that all four pins are pressed down on the board as far as they'll go. Then solder all pins.
- Install the RCA jack, J7. The small plastic standoffs on the bottom of the connector should be inserted in the holes provided. While soldering, hold J7 flat against the board, and keep it centered within its component outline. Clip the leads on the bottom side.
- Locate J8, the 9-pin "D" connector, and temporarily place it in its indicated location (far right side of the board). Note that the leads of capacitors C97-C99 on the bottom of the board interfere with the proper seating of J8. To avoid this, you will need to trim off the plastic extensions on both sides of the connector. First, bend upward and cut off the thin metal tabs above the plastic extensions (do not use flush cutters for this--you may damage them) . Then trim the plastic away so that it doesn't interfere with the leads of C97-C99.



Install J8 and solder just one of the 9 pins. Adjust the position of J8 as you did for the other connectors, making sure the connector is flat against the board. Then solder the remaining pins.



You may have received two 16F872 microcontrollers with your kit. The one marked "KPA100" or "PA" should be used here. **Before handling U1 (16F872), touch a grounded surface.**



Straighten the leads of U1 (PIC16F872) as shown below. The rows of pins must be straight and parallel to each other to establish the proper pin spacing. To straighten the pins, rest one row of pins against a hard, flat surface. Press down gently on the other row of pins and rock the IC forward to bend the pins into position as shown below.

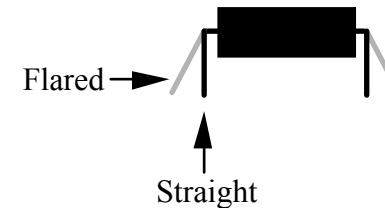

Figure 9



Insert U1 into its socket, with the notched or dimpled end of the IC aligned with the notched end of its component outline.



Examine U1 closely. If any pins are bent, remove the IC and straighten them. (To remove U1 from its socket, pry it up gently on each end using a small flat-blade screwdriver.)

Visual Inspection



Nearly all problems with kits are caused by poorly-soldered component leads or incorrectly-installed components. You can locate and correct most assembly errors ahead of time with a simple visual inspection. This is especially important at high power levels, where an unsoldered or reversed component could cause damage to the power transistors.

Verify that there are no parts installed at the following locations (In addition to the following, there are other open spaces where parts will be installed later as well) :

- C82.
- C83 (capacitor is mounted on the top of transformer T2).
- L15.
- R12.

Using a magnifying glass, examine the bottom of the PC board closely for all of the following: cold solder joints (dull rather than shiny appearance), solder bridges, and leads that are not soldered. Re-heat any suspect joints.

Using the parts placement drawing at the end of the appendix, re-check the orientation of all:

- Diodes
- Transistors
- ICs

Initial Tests

Make the resistance measurements listed below, touching the DMM's (+) and (-) leads to the indicated points. The (-) lead will go to ground in all cases except the first measurement (relay coils).



The symbol > means *greater than*. Your DMM may indicate infinite resistance (all digits flashing) for readings that are listed as "> 10 k." (Do not use an analog VOM.) Other readings should be +/- 10 %. K4 reads higher resistance than the other relays because K3 is not yet installed (the two coils are in parallel).

KPA100 Test Points (+, -)	Resistance
(+) and (-) leads of relays K1,K2,K4-K12 (on bottom of board, marked)	650-800 (K4) 325-400 (others)
U1 pin 1, ground	> 1 k
U1 pin 2, ground	> 10 k
U1 pin 3, ground	> 10 k
U1 pin 4, ground	3.1 k
U1 pin 13, ground	> 10 k
U1 pin 14, ground	> 10 k
U1 pin 27, ground	> 10 k
U1 pin 28, ground	> 10 k
U4 pin 1, ground	> 10 k
U4 pin 8, ground	> 10 k
"AF" pad (measure from bottom), ground	> 10 k
D10 banded end, ground	> 10 k

Determine what revision of firmware your K2 has installed at present by turning the K2 on while holding any switch. Record the number shown at the *left* end of the LCD (e.g., **2.01H**): _____.

- Turn off the K2. Disconnect all external cables.
- Remove the six K2 top cover screws shown in Figure 10.
- Remove the top cover. Disconnect the speaker and all options.

- Store the top cover in a safe place to protect the finish.

 You can easily remove the KPA100 and re-install the original top cover at any time, returning the K2 to its low-power field configuration.

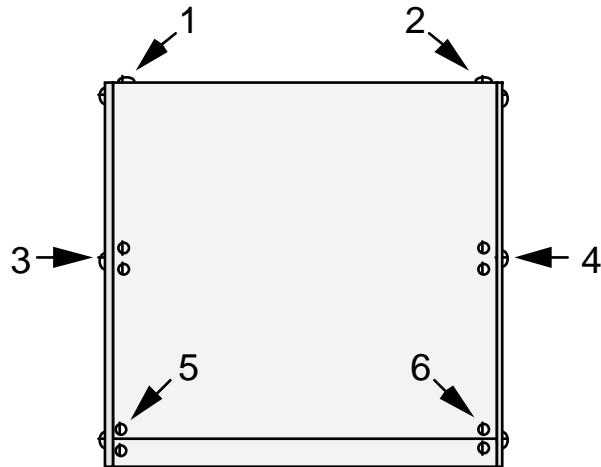



Figure 10

 **Before handling the Control board in the following steps, touch a grounded surface.**

- Remove the screws that hold the K2 Control board to the front panel board. Also remove the KAF2 audio filter board if present.

Use the long-handled Allen wrench supplied with the K2 to pry the Control board up at the point marked "LIFT HERE" on the RF board. Then unplug the Control board. Place it in front of you with the component side up.

- Locate C42 on the K2 Control board (**CTRL-C42**), which is near the voltage selector switch, S1. If the present value of this capacitor is .01 μF ("103"), replace it with an 0.1 μF capacitor ("104"). Use a capacitor with 0.2" lead spacing. **Note:** If you have an older Control board (rev XC) that does not include C42, solder the 0.1 μF capacitor between pins 4 and 8 of U3 (LMC6482, on the Control board).

 A ribbon cable is used to connect the KPA100 board to the K2 Control board. To ensure correct cable orientation, *keying inserts* are used. This requires cutting one pin on the male connectors at each end. The pin to be cut, 8T (8-volt transmit), is not used by any Elecraft option. If you need 8T for any reason, skip the next three steps, as well as the last step on this page.

- Locate P4 on the Control board, a 10-pin, dual row (5 x 2) male connector (see Figure 11). P4's pins are numbered left to right, top to bottom (pin 2 is to the right of pin 1, pin 3 is below pin 1, etc.).

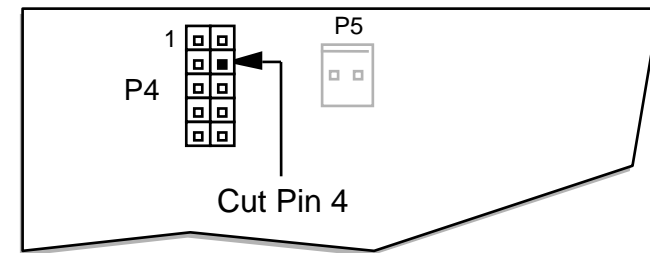

Figure 11

- Cut pin 4 of P4 as indicated above, as close as possible to the connector's plastic body. The best way to do this is to grasp the pin with long-nose pliers, then bend it repeatedly until it breaks off.

- Cut pin 4 of P1 on the KPA100 board (see Figure 12).

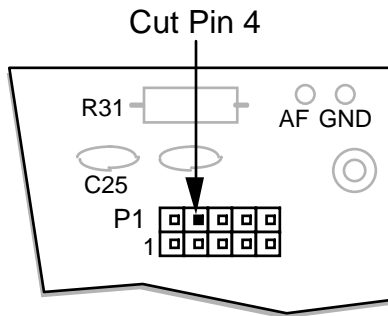

Figure 12

- Locate the pre-assembled ribbon cable. Lay the cable flat as shown in Figure 13, **with the black wire at the top and the connector holes facing up.**

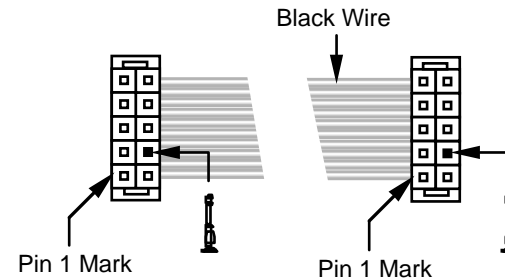



Figure 13

- The main microcontroller (U6, K2 Control board) must have revision 2.02A or later firmware in order to control the KPA100.** If your firmware revision (recorded on the previous page) is older than this, you'll need to install a new microcontroller. This 40-pin IC should have been supplied with your KPA100 kit. Refer to the K2 Revision 2 Firmware manual for installation instructions.
- If you plan to use computer control of your K2 via the KPA100's RS-232 interface, and have not previously installed the KIO2 option, you may need to modify the Control board (see page 59). Making the modification now will save you the trouble of removing the Control board again later.
- Plug the K2 Control board into the RF board. Make sure that all three connectors along the bottom edge of the board are plugged into their mating connectors.
- Re-install the KAF2 board if applicable. Secure the Control board to the Front Panel board with the hardware removed earlier.

 **Before installing the keying inserts in the next step, carefully check to ensure they are in the correct positions! Once inserted, they are almost impossible to remove.**

- Install keying inserts in position 4 of both connectors. The inserts include break-off tabs that aid installation. The inserts should lock in place and be flush with the mating surface of the connector.

 The cables that connect the KPA100 to the K2 are all kept short to avoid pickup of stray RF. Because of this, the KPA100 assembly must be placed on top of a 3 to 4 inch (7 to 10 cm) platform to the right of the K2 during test and alignment. You can use books, a cardboard box, etc. Do not use metallic objects.

- Place the KPA100 on a suitable platform as described above. The front edge of the KPA100 board should be facing toward you (speaker cutout to the right).

Plug one end of the ribbon cable into the Control board at P4. The correct end can be determined from Figure 14. The black wire should be oriented toward the lower end of P4 (away from pin 1). If the indicated end of the ribbon cable cannot be plugged in at P4, the keying insert may be installed at the wrong position.

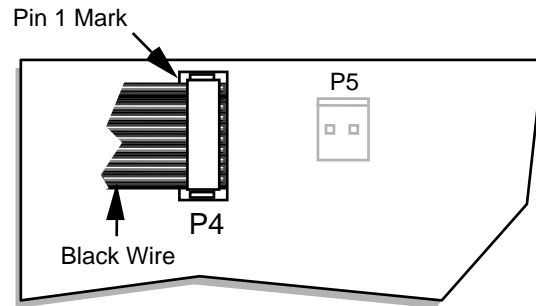

Figure 14

Plug the other end of the ribbon cable into the KPA100 at P1. The correct orientation is shown in Figure 15.

The SSB option microcontroller (U1, KSB2) must have revision 1.06 firmware or later. Check the label to determine the revision. If it's older than 1.06, a new 28-pin IC (16C72A or 16F872) should have been supplied with your KPA100 kit. Install it at this time, with pin 1 of the IC oriented toward the **left** side of the K2.

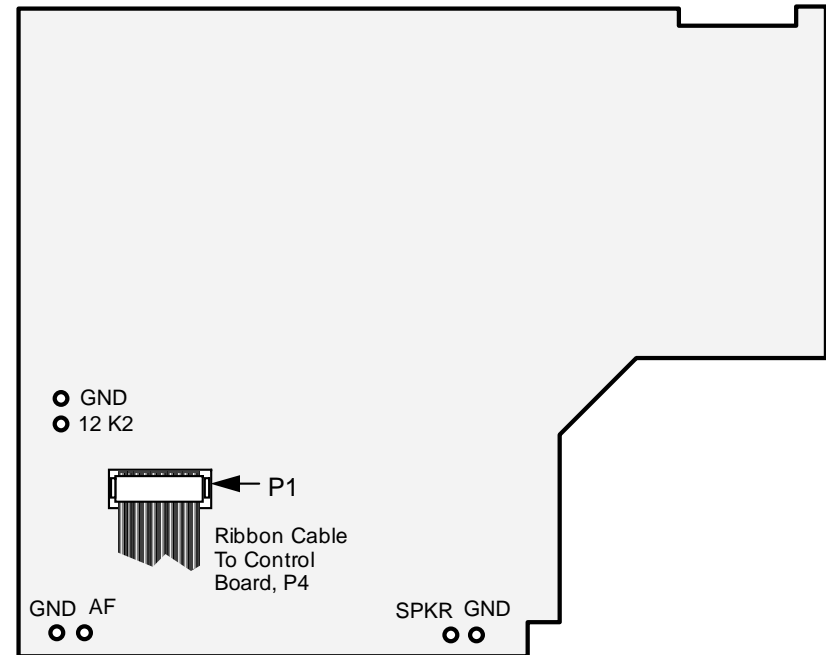

Figure 15

Connect a 12-14 volt power supply or battery to the K2's DC input jack (DC barrel connector, J3 on the RF board).

Turn on the K2; you should see **ELECRAFT** on the LCD, followed by **NO PA PS**. This message is a reminder that no high-current power supply is connected to the KPA100 yet. You may also hear relays switching on the KPA100 (in addition to the K2 relays).

Tap **DISPLAY** to check the K2 power supply voltage (**E**) and current (**i**). If the voltage is lower than expected, or the current is over **0.50** amps, refer to Troubleshooting (page 64 of this appendix). **Note:** Installing the KPA100 increases K2 receive-mode current drain by approximately 100-200 mA. In transmit mode, additional current is drawn, but this will not be included in the voltage/current display.

Tap **DISPLAY** until the frequency display returns.

Set your DMM for DC volts, 20 or 30 V full scale (or auto ranging). Connect the DMM's (-) probe to the ground jumper on the KPA100 board (near U1). Using the DMM's (+) probe, make the voltage measurements listed below. Voltages should be within +/- 10% except as noted.



When making measurements at IC pins, be careful not to short adjacent pins. Use only a fine-tip DMM probe. Do not attempt to make measurements using a wire or a probe with a large, blunt tip.

KPA100 Test Point (+)	Voltage
U1 pin 1	5.0
U1 pin 7	0 to 0.1
U1 pin 13	0 to 0.1
U1 pin 14	0 to 0.1
U1 pin 15	0 to 0.1
U1 pin 20	5.0
U1 pin 27	5.8
U1 pin 28	5.7
U2 pin 10	12-15
U4 pin 1	12-15
U4 pin 11	5.0
U5 pin 1	0 to 0.1
U5 pin 7	0 to 0.1
U6 pin 6	0 to 0.5

Tap **MENU**, then tap **DISPLAY** to bring up the K2's *secondary menu* (**SEC** will be flashed). This menu is used to configure various features that are available in K2 revision 2 firmware.

Use the VFO knob or the **BAND+** / **BAND-** switches to scroll to the **PA** menu entry. If you see **PA --**, the KPA100 microcontroller is not communicating properly with the K2. Refer to Troubleshooting.

The **PA** parameter will probably be set to **OFF** initially. Hold **EDIT** to highlight the parameter, then scroll until you find an entry starting with **E** (error status). The error status should be **E12**, where **1** indicates that the KPA100 is in bypass (QRP) mode, and **2** indicates that no KPA100 power supply is present. If you see any other error numbers, see *Error Status* in the Troubleshooting section.

Set the **PA** parameter to **ON**. Tap **MENU** to return to menu scroll mode.

Tap **DISPLAY** to return to the primary menu (**PRI** will be flashed). Tap **MENU** again to return to the normal frequency display.

Turn off the K2 and disconnect the power supply.

Disconnect the KPA100 end of the ribbon cable.

Assembly, Part II

A number of toroidal inductors are used on the KPA100 PC board.¹ The first inductor to be wound uses a type T50-10 core. The letter *T* identifies this as an *iron-powder* core. *50* specifies the outside diameter in hundredths of an inch, in this case 0.5 inches (12.7 mm). The *-10* suffix refers to the core type and color, in this case a black iron-powder core.

There are also two *ferrite* toroid cores used, such as type FT37-61. In this part number, *FT* identifies the core as ferrite, and *37* is the size (0.37", 9.5 mm). The *-61* identifies the type of ferrite, although all the ferrite cores are dark gray in color. (There are also two "binocular" ferrite cores in the kit, which will be described later.)

Three types of enamel wire are supplied with the kit: #22 red, #26 red, and #26 green. #22 wire is much larger in diameter than #26. Be sure to use only the type called for in the instructions; do not substitute other wire types. Cut wires to the specified lengths to avoid running out of wire.

Eight **black** iron-powder toroid cores are supplied with the kit. These are type **T50-10** (0.5" [12.7 mm] dia.). Locate one of these cores for use at L4. (Don't use the dull-gray FT50-43 core.)

Find the component outline for L4, at the left side of the board near relay K5. Compare this component outline to Figure 16, which shows two views of a typical toroidal inductor. L4 will be mounted vertically as shown at the right side of the drawing, with one wire exiting at the core's upper left, and the other at the lower right.

 **#22 enamel wire is fairly stiff, and may be difficult to wind tightly onto the core. The turns should not be loose, but it is acceptable to have a very small gap between the wire and the core's flat surfaces. If you try to wind so that it "hugs" the core all the way around, you may have to pull the wire too hard, resulting in hand fatigue.**

Cut 15 inches (37 cm) of **#22 red** enamel wire. To wind L4, "sew" the long end of the wire through the T50-10 core. *Each pass through the core counts as one turn.* 17 turns are needed, as shown in Figure 16. The enamel insulation will be removed in a later step.

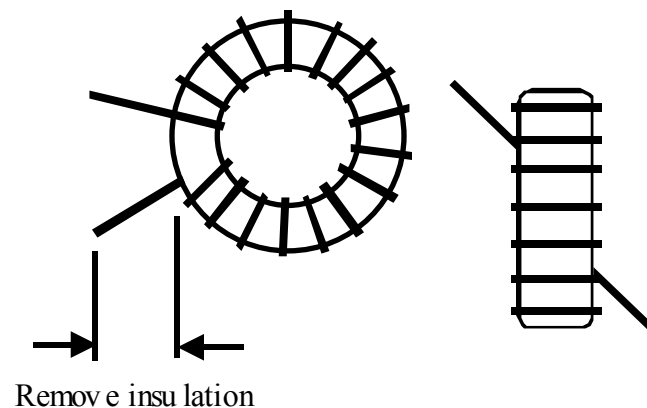

Figure 16

Verify that the turns of L4 are not bunched together. They should be evenly spaced, and should occupy about 80-90% of the core. Proper turns spacing is shown in the photograph below (Figure 17).

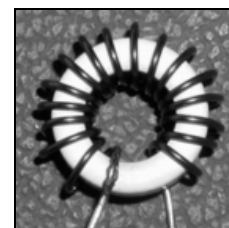

Figure 17

Toroids shown in photos are wound on white cores to highlight turns counts and spacing. **Place L4 on top of the photo above, then adjust the turns spacing until it is similar to that shown.**

¹ Pre-wound toroids are available from an Elecraft-approved source; see page 3.



The enamel wire can be heat-stripped. Place a small amount of solder (a "blob") on the end of your soldering iron, then insert the clipped end of the wire into the hot solder. If the iron is hot enough, you should see the insulation bubble after 4 to 6 seconds. Add more solder and feed more of the wire into it as the enamel melts. Continue tinning the wire up to slightly past the edge of the core, then slowly pull the wire out of the solder. If any enamel remains on the lead, scrape it away using your fingernail. You can also burn the insulation off by heating it with a butane lighter for a few seconds, then use sandpaper to remove the residue. If you scrape the insulation off with a razor blade, avoid nicking the wire.

- Strip the leads of L4 as described above. Remove the enamel from the leads up to the edge of the core (see Figure 16).
- Tin L4's leads. If the solder on the leads looks dull or is not adhering very well, remove any residual enamel and re-tin the lead.
- Install L4 vertically as shown by its component outline. Pull the leads taut on the bottom of the board.
- Solder the leads of L4. When soldering, make sure that the solder binds well to the leads. **If the lead appears to be an "island" in a pool of solder, it is not making good contact; remove the toroid and prepare the leads as described above.** (For further information, look for "Soldering Tips" on our web site.)



Do not apply adhesives or fixatives of any kind to toroids.

- Using your DMM on a low resistance scale, check for continuity between L4's pads (not the leads) on the bottom of the board. If the reading is over 1 ohm, re-strip the leads. **Note:** Your DMM probes will have some residual resistance. Short them together to measure this amount, and subtract it from your continuity readings.
- The other low-pass filter toroids are shown in the photos at right (Figure 18). Wind each of these toroids using the indicated powdered-iron cores, either **RED** (T50-2) or **BLACK** (T50-10). All are wound using #22 enamel wire. Use the wire length and number of turns shown.
- Prepare the leads of these toroids as you did for L4.

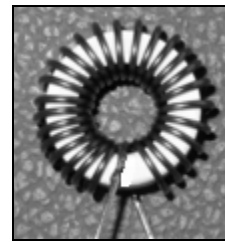

__ L1: 27 T, **RED**
22" (56 cm)

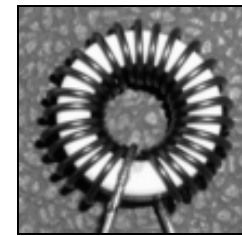

__ L2: 25 T, **RED**
21" (53 cm)

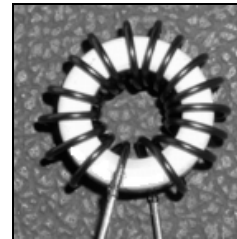

__ L5, 16 T, **BLK**
14" (36 cm)

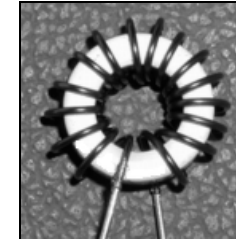

__ L6, 16 T, **BLK**
14" (36 cm)

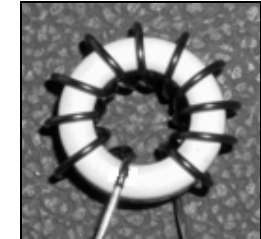

__ L7, 11 T, **BLK**
10" (26 cm)

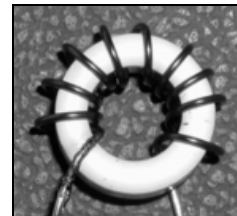

__ L8, 10 T, **BLK**
9.5" (24 cm)

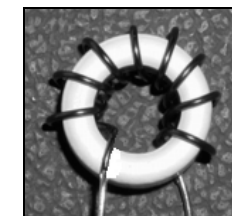

__ L10, 9 T, **BLK**
9" (23 cm)



__ L11, 8 T, **BLK**
8" (20 cm)

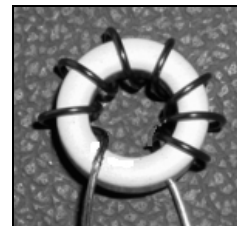

__ L12, 8 T, **BLK**
8" (20 cm)

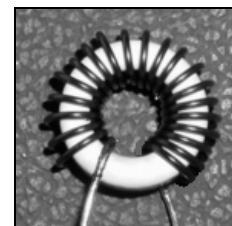

__ L13, 21 T, **RED**
18" (45 cm)

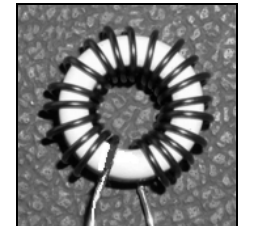

__ L14, 20 T, **RED**
17" (43 cm)

Figure 18

- Place each of the low-pass filter toroids on its photo and adjust the turns spacing so it is similar to that shown. Re-check turns counts and core colors. (Each pass *through* the core counts as one turn.)

 Good electrical contact between toroid leads and their pads is critical for safe and reliable operation at high power levels. If you see any indication that the solder is not binding well to a lead, remove the toroid and prepare the leads again.

- Install L1 vertically as indicated by its component outline (near relay K3).
- Install and solder the remaining low-pass filter toroids. Match each of the low-pass filter toroids to its reference designator carefully. Exchanging any of them will result in poor performance on two or more bands.
- On the bottom side of the board, check for continuity between the pads of all the low-pass filter toroids. If you get a reading of > 1 ohm, remove the toroid from the board and prepare the leads again.
- Prepare L16 and RFC1 as follows:
 1. Use T50-1 cores: blue, 0.5" (12.7 mm).
 2. Cut 26" (66 cm) lengths of **#26 red** enamel wire (the smaller gauge red enamel wire) for each inductor.
 3. Wind 37 turns on each core as shown in Figure 19.



Figure 19

- Prepare the leads of L16 and RFC1 as before.
- Install L16, located near relay K2.
- Install RFC1, located near RFC1. Note that the outline for RFC1 is for an in-line leaded part, not a toroid. RFC1 is a toroid. Place it within the outline.
- Locate the two dark gray (ferrite) toroid cores. The smaller of the two (type **FT37-61**) has a diameter of 0.37" (9.5 mm). This core will be used in the following steps.

 Toroidal transformer T3 uses a *bi-filar* winding, which means that two wires are wound on the core together. The wires will be twisted together loosely before they're wound onto the core.

- Cut two 8" (20 cm) lengths of **#26 enamel wire, one red and one green.**
- Twist the red and green wires together over their entire length. The wires should cross over each other about every 1/2" (1 cm).
- Wind 7 turns of the twisted wires onto the small ferrite core (FT37-61). The turns should be spaced to cover about 80-90% of the core, as shown in Figure 20 and Figure 21. **Note:** To make the turns spacing easy to see, the wires shown in Figure 20 were not twisted together.
- Separate T3's leads as shown in Figure 21. The numbers on the leads correspond to numbered pads on T3's PC board outline.

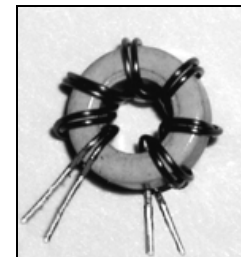

Figure 20

- Strip and tin the leads of T3. (Figure 20 shows the leads tinned.)

Keep the red and green leads spaced slightly apart during stripping and tinning.

- Using a magnifying glass, examine the red/green lead pairs to make sure that the leads are not shorting together near the core.
- Install T3 vertically on the PC board as indicated by its outline (near the microcontroller, U1). Insert the red and green leads into their numbered holes as shown in Figure 21. Pull the leads taut on the bottom, then solder.

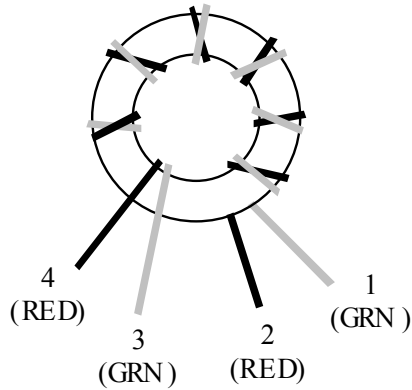

Figure 21

- Verify continuity between the #1 and #4 pads of T3. If you get a reading over 1 ohm, remove T3 and prepare the leads again.
- Transformer T4 also uses a bifilar winding. Cut two 11" (28 cm) lengths of #26 enamel wire, one red and one green. Twist the red and green wires together as you did for T3.
- Wind 12 turns of the twisted wires onto the large ferrite core (FT50-43). The turns should cover about 80-90% of the core, as shown in Figure 22 and Figure 23.

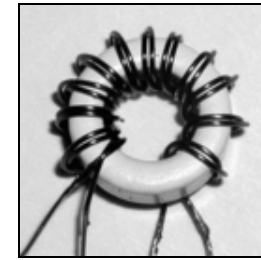

Figure 22

- Separate T4's leads as shown in Figure 23. The numbers on the leads correspond to numbered pads on T4's PC board outline.
- Strip and tin the leads of T4.
- Using a magnifying glass, examine the red/green lead pairs to make sure that the leads are not shorting together.

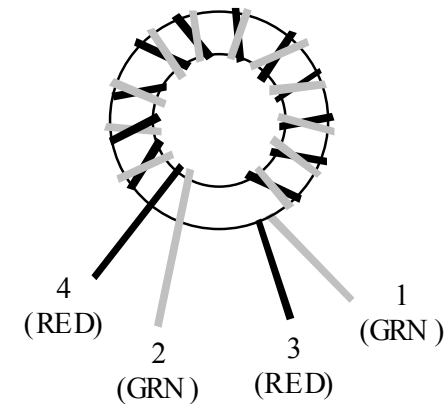



Figure 23

Install T4 vertically on the PC board as indicated by its outline near the small notch (back edge). Insert the red and green leads into their numbered holes as shown in Figure 23.

 **T4's leads are numbered differently from T3's. Be sure to insert the leads into the correct numbered holes in the PC board, or the SWR bridge will not properly indicate forward and reflected power. This could result in damage to the power transistors.**

Verify continuity between the #1 and #4 pads of T4.

Locate the two ferrite beads (gray) for use at Z1. Slip the two beads onto a lead previously saved from a 1N4007 diode or 3-watt resistor. **A heavy component lead must be used in order to handle the full power transistor current. DO NOT use a 1/4-watt resistor lead or small-gauge wire.**

Install this assembly at Z1, which is near the hole for RF power transistor Q1. Form the leads to match the indicated pad spacing.

Install an insulated jumper wire between the pads of L18. Use 3/4" (19 mm) of the solid-conductor #24 hookup wire. Strip 1/4" (6.3 mm) from each end.

 Figure 24 (page 32) shows the connectors and other hardware that will be attached to the rear panel in the following steps. The antenna jack (J2), DC power jack (J3), and fan will be secured to the panel first, then the rear panel assembly will be attached to the KPA100 PC board.

Unwrap the rear panel. Orient it with the antenna jack at the left.

If masking tape (usually green in color) is present on the inside surface of the rear panel, you'll need to remove it. Use a ball-point pen to push on the tape through each hole until the tape lifts away. Then peel the tape off, using a sharp tool if necessary. Be careful not to scratch the outside surface of the panel.

Place the antenna jack, J2 (SO239) in its position on the rear panel as shown in Figure 24. **The connector's square flange goes on the outside of the panel (the side with the labeling), not the inside.**

 **Always use bright (zinc-plated) hardware unless an item is described as *black* in the instruction step.**

Attach J2 to the rear panel as shown in Figure 24. Use four 4-40 x 1/4" (6.4 mm) pan head screws, one solder lug, **three** #4 split lock washers, and four 4-40 nuts. As shown in Detail A1, the solder lug takes the place of one lock washer. The lug must be installed on the screw nearest the top edge of the rear panel. **Do not overtighten the hardware.**

Locate the four fan mounting holes (countersunk from the inside of the panel). Test a 4-40 flat-head screw at each screw location, and remove any burrs that might be obstructing flush seating of the screw head.

A small hole is provided near one of the countersunk holes for routing the fan wires. Insert the fan wires into this hole, and orient the fan as shown. The label side of the fan should face *away* from the panel.

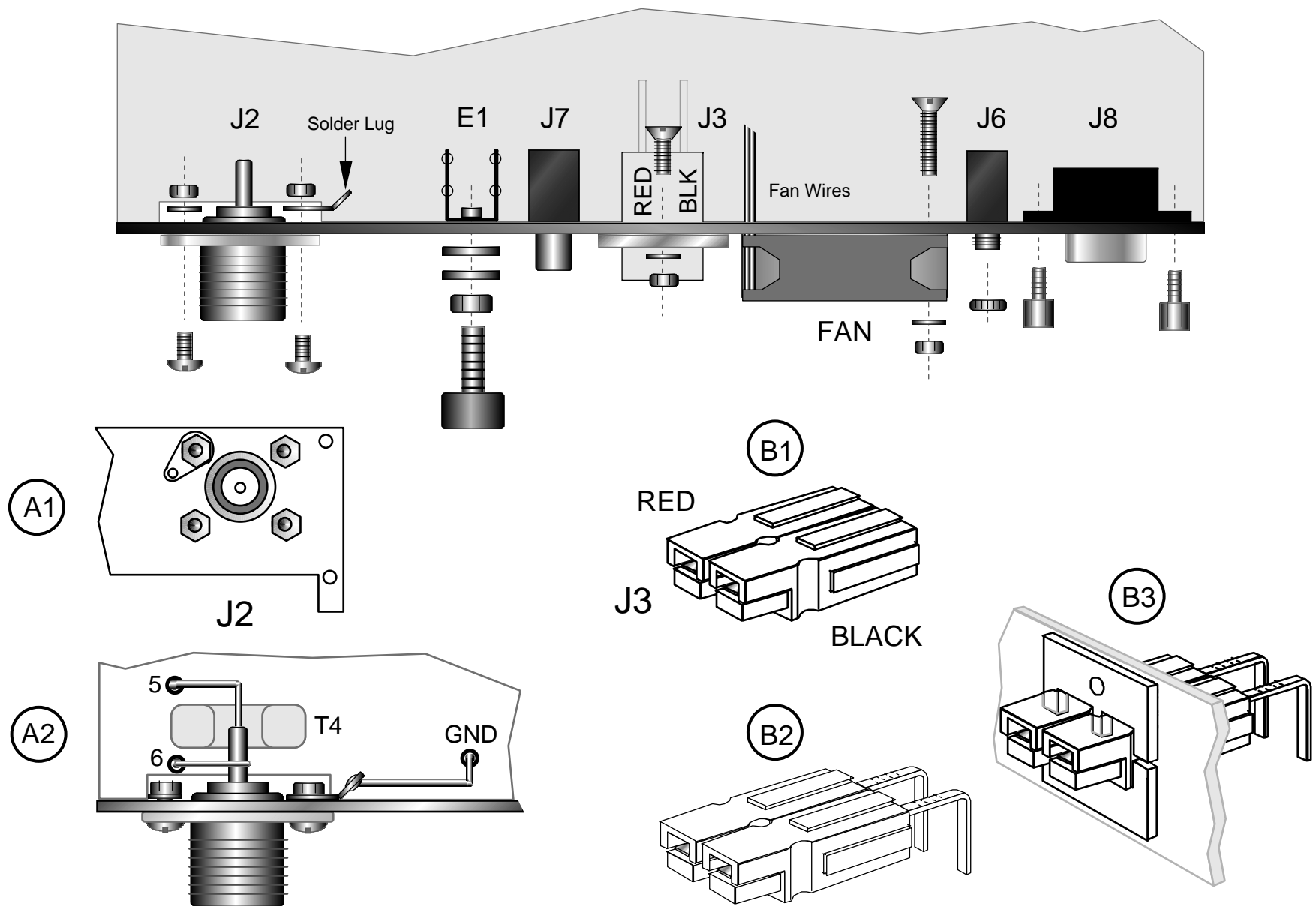



Figure 24

- Cut the two fan wires to a length of 2" (5 cm), measured from where they exit the fan's frame. Remove 1/4" (6.4 mm) of insulation from each wire, then twist together and lightly tin the strands.
- Secure the fan to the rear panel using four 4-40 x 11/16" (17.5 mm) flat head screws, four #4 split lock washers, and four 4-40 nuts.
- Locate two DC input connector housings, one red and one black. Hold the two connectors in the orientation shown in Detail B1 of Figure 24. Look closely at the sides of the connectors. Each has a small tongue on the right side, and a groove on the left.
- Slide the tongue on the right side of the red housing into the groove on the left side of the black housing. Make sure the housings are mated exactly as shown in Detail B1, with the black housing to the right and the "hoods" at the front of the connectors facing up. Make sure the interlocking tongue and groove are fully meshed.
- Install right-angle PCB pins into the housings (Detail B2). The long end of the pin should be inserted into the housing until it snaps into position, and the short end must point down. When the pin is correctly inserted, the distance from the back end of the housing to the bend in the pin will be exactly 0.4" (10 mm).
- Insert the paired housings through the rectangular rear-panel hole, with the red housing aligned with the "+" label.
- Use two E-shaped brackets to hold the housings in place, as shown in Detail B3 (one from above, one from below). Secure the brackets to the rear panel using two 4-40 x 1/4" (6.4 mm) flat head screws, two #4 split lock washers, and two 4-40 nuts. This hardware is shown in Figure 24 (at top).
- Cut two lengths of #20 insulated hookup wire: one **black**, 1.5" (4 cm) long; and one **red**, 1.25" (3.2 cm). Remove 1/4" (6 mm) of insulation from each end of both wires.

- Solder one end of the **red** wire to the center pin of the antenna connector (J2) as shown in Figure 24, Detail A2. Remove any excess solder from the outside of the pin using desoldering braid.
 - Solder one end of the **black** wire to the solder lug.
 - Make a 1" long jumper using a discarded component lead (from a small resistor or capacitor). Solder one end of this jumper to the center pin of J2, as close to the body of the connector as possible (Detail A2). Leave the other end free, oriented as shown.
 - Remove the finishing nut from the external speaker jack (J6).
 - Install the rear panel assembly onto the KPA100 PC board, **threading J2's red wire through the center of transformer T4**. At the same time, insert J3's leads into their holes.
 - Verify that the red wire from J2 has been passed through T4
 - Secure J6 (EXT SPKR) to the rear panel with its finishing nut.
 - Secure J8 (AUX I/O jack) to the rear panel using two male-female standoffs. **Do not overtighten the standoffs.**
 - Secure E1 (GND) to rear panel with the 6-32 thumbscrew, 6-32 nut, and two #6 flat washers. The nut must be installed between the washers and thumb screw as shown to ensure good electrical contact.
-  The rear panel should now be flush with the back edge of the PC board. If not, one of the connectors may not be properly installed.
- Solder J3's leads to the board. **These connections are critical to reliable operation. The solder should coat J3's pads on both sides of the board, and the joints should be clean and shiny.**
 - Trim J3's leads on the bottom of the board.

- Solder the red fan wire to the pad labeled "FAN+" (near J6). Solder the black fan wire to the "FAN-" pad.
- Route the fan wires away from RFC1.
- Solder J2's wires to the points indicated in Detail A2 of Figure 24. The red wire goes to T4 pin 5, black wire to the pad labeled "GND" near E1, and bare wire jumper to T4 pin 6.
- Examine the area around J2 closely to make sure that none of the wires running to the center pin are touching nearby hardware.
- Locate the smaller binocular coil form for use at T1. As shown in the side view, Figure 25a, the ferrite core is offset upward slightly, leaving a gap at the bottom. The end view, Figure 25b, identifies contacts 1 and 3. The other end is contact 2.

- Place T1 at its indicated location, with the gap (bottom side) toward the PC board. Contacts 1, 2, and 3 must be aligned with their PCB pads. Figure 25c shows all of T1's pads (1-5).

 T1 is very difficult to remove once installed. While soldering, make sure it is centered directly over its component outline and is seated flat against the board. T1 may be just slightly larger or smaller than the indicated outline.

- Using a heavy soldering iron (pencil or gun), *solder only contact 1* of T1 to the board. Solder over the full length of the contact.
- If T1 is not centered, reheat contact 1 and adjust its position.
- Solder contacts 2 and 3. Solder along the full length of each contact.

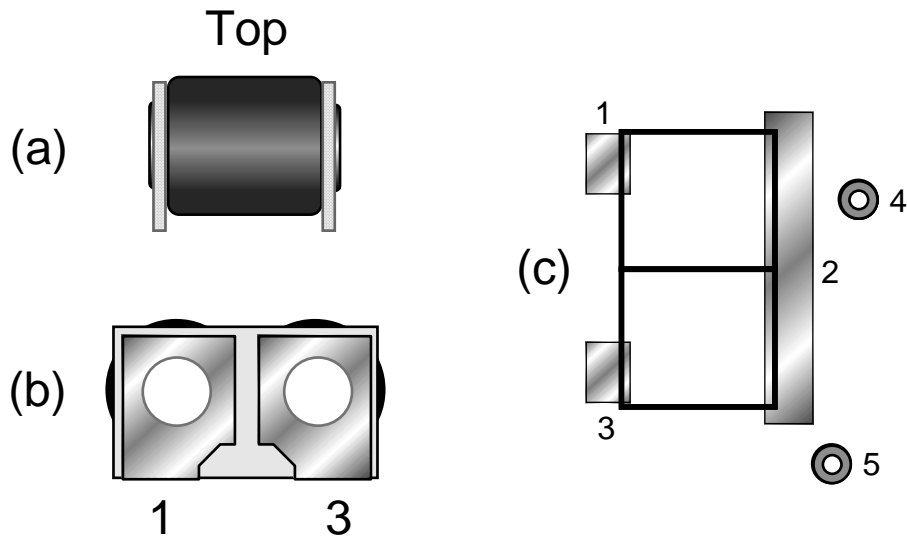

Figure 25

- There are two sizes of **Teflon** wire (gray): #18 (larger) and #22 (smaller). **The smaller size will be used at T1, and the larger at T2.** Cut a 9" (23 cm) length of the #22 Teflon wire.
- Remove 1/4" (6 mm) of insulation from *one* end, then twist the strands together. Tin the strands using a small amount of solder.
- Solder the Teflon wire to the pad labeled T1-4.
- Thread the wire through the core (1 turn) as shown in Figure 26a. You'll then have one loop of wire on the left side of the core.
- Add a second turn by passing the free end of the wire back through both holes in the core, as you did in (a). Pull on the wire so that the winding is tight. The winding should then look like Figure 26b, with two loops on the left side.
- Add a third turn, again passing the free end back through both holes in the core (Figure 26c). Pull the wire to tighten the winding.
- Count the loops on the left side to make sure you now have exactly three.** There will be two loops on the right side, plus the two ends of the wire.
- Cut the free end of the wire to a length of 5/8" (16 mm), measured from where it exits the core. Remove 1/4" (6 mm) of insulation, then twist and tin the leads.
- Solder the wire to the pad labeled T1-5.

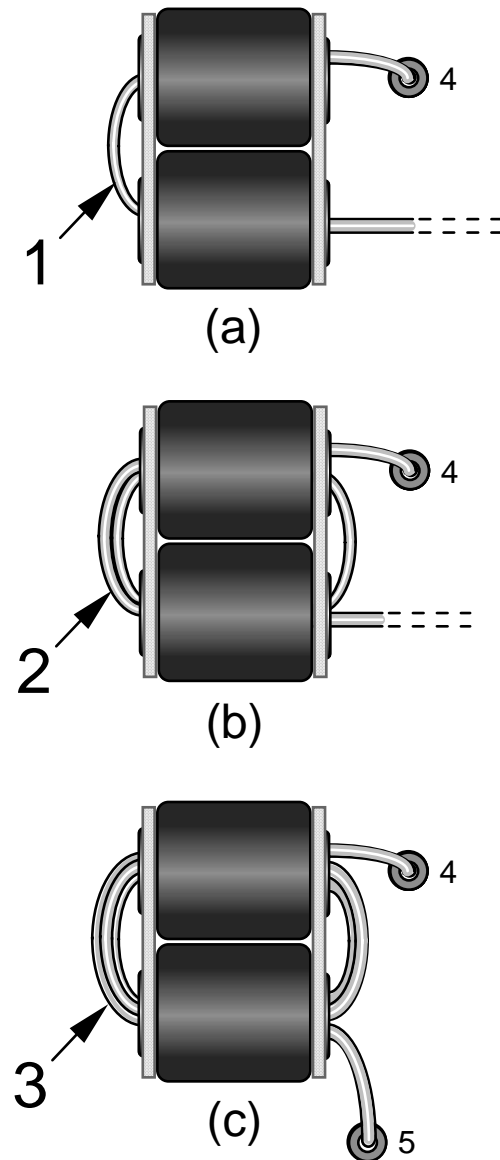

Figure 26

Locate the larger binocular coil form for use at T2. Note: T2 may vary in length from 1" to 1 1/8" (25 to 29 mm). The given pads can accommodate either length. Figure 27 shows all five of T2's pads.

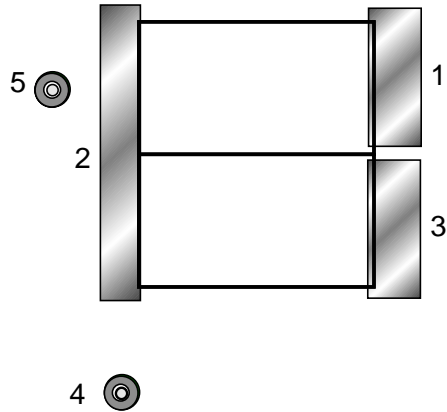



Figure 27

Center T2 at its indicated location with the gap (bottom side) toward the board. Contacts 1-3 must be aligned with their PCB pads.

 Once T2 is installed, it is nearly impossible to remove. While soldering T2, make sure it is centered directly over its component outline and is seated flat against the board.

- Using a heavy solder iron, solder contact 1 to its pad *over just a small portion of its length*.
- If T2 is not centered over its component outline, or is tilted, reheat contact 1 and adjust T2's position.
- Solder contact 3 over its full length.
- Solder contact 2 over its full length. Keep the iron tip away from nearby components, especially potentiometers R26 and R27.
- Solder contact 1 over its full length.

Cut an 18" (46 cm) length of #18 Teflon wire (**gray**). Remove 1/4" (6 mm) of insulation from one end, then twist and tin the strands.

- Solder the Teflon wire to the pad labeled T2-5.
- Thread the wire through the core (1 turn) as shown in Figure 28a.
- Add a second turn, pulling the wire so that the winding is tight. The winding should look like Figure 28b (2 loops on the right).
- Add two more turns (c), (d). Pull the wire to tighten the winding. **There should now be exactly four loops on the right side.**
- Cut the free end of the wire to a length of 1 1/4" (32 mm), measured from where it exits the core. Remove 1/4" (6 mm) of insulation, then twist and tin the strands. Solder the wire to T2-4.

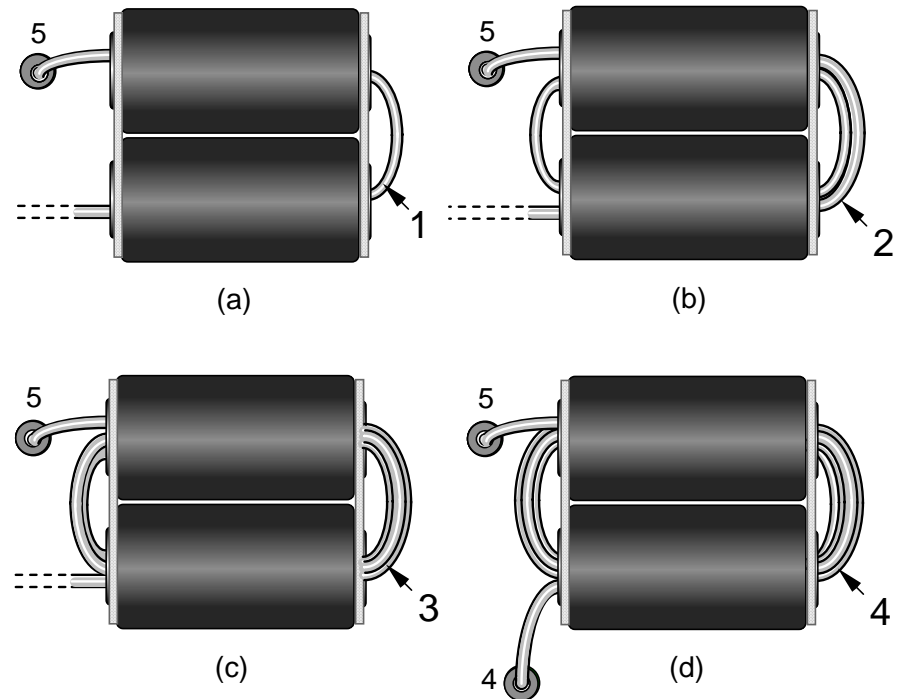



Figure 28

Install the following resistors near T1. **Note:** Two sizes of 10-ohm resistors are to be installed. The first to be installed, R9, is the smaller size, rated at 1/4 watt. The other 10-ohm resistors are much larger and rated at 2 watts.

- R9, 10 ohms, 5%, 1/4 W (brown-black-black)
- R34 and R35, 10 ohms, 2 W
- R19 and R20, 1.6 ohms, 2 W
- R22, 300 ohms, 2 W
- R21, 10 ohms, 2 W (form leads to fit given pad spacing)

Install an insulated jumper wire between the pads of R23. Use 1" (25.4 mm) the solid-conductor #24 hookup wire and strip 1/4" (6.3 mm) from each end.

Install relay K3, located near T2.

 **In the next step, when installing capacitors C2A and C6D you may find that the spacing of the leads is greater than the solder pad hole spacing. If so, reform the leads as shown below. Be sure the capacitors stand no higher above the board than shown.**

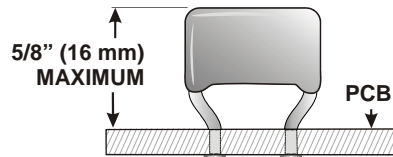

Install the following capacitors in the low-pass filter area:

- C2E, 1000 pF, 500 V silver mica
- C2A, and C6D, 1200 pF, 630 V polypropylene (6122)
- C2C, 2200 pF, 500 V silver mica

Install the following capacitors, located in the area between the two power transistors.

- C58 and C59, 0.1 μ F (104), 0.2" lead spacing
- C80 and C81, 4700 pF (472), 0.25" lead spacing

Unwrap the heat sink and place it on a soft, clean surface to protect the finish. Orient it with the speaker hole at top left and fins facing down (see Figure 29 on next page). The raised area on the right side is the *pedestal*, where the power transistors will be mounted. The PC board will be mounted at the seven points marked *H* and *S*.

 **The heat sink has a non-conductive, black oxide finish. To ensure good electrical contact between the heat sink and PC board, the finish will be removed at the seven points shown at right. When working with the heat sink, be careful not to nick or scratch the fins (on the opposite side).**

Attach a portion of the supplied sandpaper (no more than 1/4th of the sheet) to a flat piece of wood or a sanding block. The block should be at least 4" long and 1" wide (10 x 2.5 cm).

Locate the two machined standoffs on the pedestal, labeled *S* in Figure 29. Lay the sanding block across the top surfaces of *both* standoffs. Keeping the block parallel to the pedestal at all times, carefully sand off just enough of the black finish to expose the top surfaces of the standoffs. **Do not remove any further material, since this may affect proper spacing of the power transistors.**

Use the sandpaper (but *not* the sanding block) to remove the finish around the holes labeled *H* in Figure 29. The area of finish removed should be approximately centered over each hole, and at least 1/4" (6 mm) in diameter. **Note:** You can also scrape away the anodization with a sharp tool or a hand mill (Dremel tool) with a wire-brush attachment. Be careful not to cut down into the aluminum.

Locate the 7 set screws (4-40 x 1/2") and the small hex wrench. Thread a set screw into each hole marked *H* or *S*, being very careful not to cross or strip the threads during insertion. Tighten the set screws using the hex wrench. **Do not over-tighten the screws or you will strip the threads!**

Thread 3/16" dia., 3/16" long standoffs onto the five set screws marked *H*. **Do not use lock washers.** Tighten the standoffs using pliers, but do not over-tighten.

- Using your DMM's lowest resistance scale, check for continuity (< 1 ohm) between one set screw and all of the others.

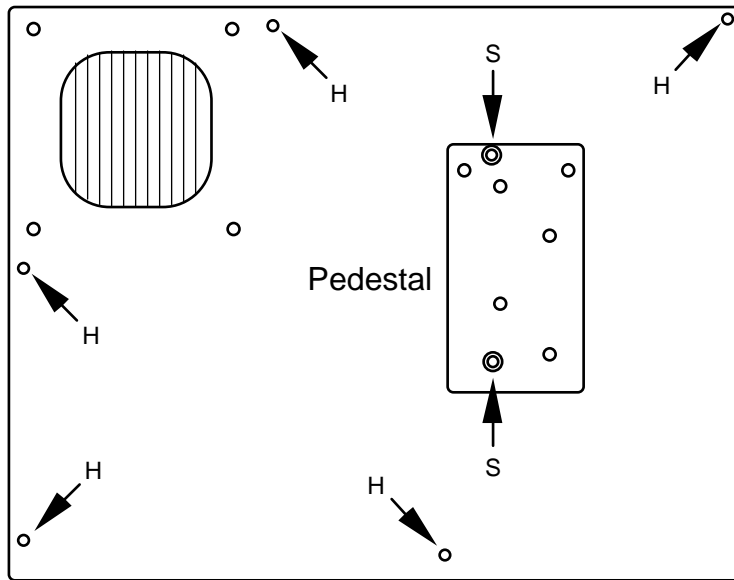

Figure 29

i The leads of some components near the power transistors must be flush-trimmed as explained in the next step. This will prevent leads from shorting to the pedestal.

- Flush-trim the leads of the components listed below on the bottom of the board. The leads must be less than $1/32$ " (0.7 mm) long.

__ C40	__ C50	__ C80	__ C81
__ C58	__ C59	__ C31	__ L18 (jumper)
__ Z1	__ L16		

- Over the rest of the board, trim any component leads that you may have missed earlier, including connector leads. Use a ruler to make sure that all leads are trimmed to less than $1/8$ " (3 mm).

i The PC board will be attached to the heat sink temporarily in the next step. This will position the power transistors correctly for soldering. Do not install thermal pads at this time.

- Place the KPA100 PC board assembly on top of the heat sink. Secure the board to the heat sink at the pedestal set screws using $1/2$ " (12.5 mm) long standoffs. Thread them on hand-tight only.
- Locate the two flange-mount power transistors. If the tabs are bent, straighten them carefully using long-nose pliers.
- Pre-tin the tabs of Q1/Q2 (top and bottom) with a small amount of solder. Also pre-tin the pads for Q1 and Q2 on the PC board. **A high-wattage iron will be required to tin the emitter pads.**
- Place power transistors at Q1 and Q2, orienting the four tabs as shown in Figure 30a. **The notched tab must be aligned with the PCB pad labeled "C" (collector).**

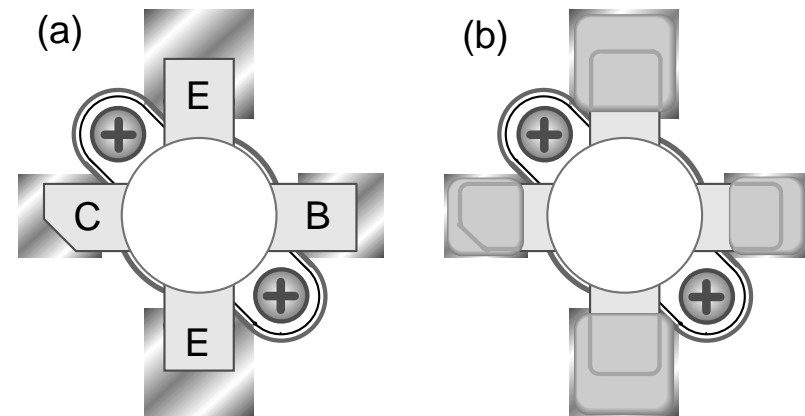



Figure 30

- Secure Q1 and Q2 to the pedestal temporarily using four 4-40 x 1/4" (6 mm) pan head screws and four split lock washers. **The lock washers must be used, or the screws may bottom out.**

 Use an iron with a large tip when soldering the emitters of Q1 and Q2. A small tip cannot supply enough heat.

- Solder all four tabs of Q1 and Q2 to their pads. The solder should coat the entire tab and the PC board pad surrounding it (Figure 30b).
- Remove the screws from Q1 and Q2.
- Remove the standoffs holding the PC board to the heat sink, then remove the board.
- Wrap the heat sink back up and set it aside.
- Install 22-ohm, 3-watt resistors at R38 and R39. These resistors straddle the nearby emitter leads of Q1 and Q2. The resistors are slightly longer than the pad spacing. Form the leads to fit. The resistors will stand about 1/16" (1.6 mm) above the board and must not touch each other.
- Solder R38 and R39, then flush-trim the leads.
- Locate a 1000-pF silver mica capacitor (C83). Bend the leads to the sides where they exit the body of the capacitor and trim them to approximately 1/8" (3 mm) long.
- Place C83 in *exactly* the position shown in Figure 31 extending horizontally away from T2 over R38 and R39. The leads normally exit the body of the capacitor near the side opposite the markings, so it will be easier to solder if this side is up as shown. There are no solder pads. The leads lay flat against the tinned end plates on T2. Tin one of the end plates where the capacitor lead will attach, leaving a small bump of solder on the plate. Then hold the capacitor in place and touch the lead and plate with your iron to flow the solder onto the lead to hold the capacitor. Solder the other lead, then go back and touch up the first lead if needed.

- Check the position of C83 to ensure that no part of the body is higher than the circuit board end plate of T2. If it is higher than the edge of the end plate, the shield may strike the capacitor when it is installed. (There is a raised area in the shield to clear the ferrite cores in T2, but it does not extend over the area where C83 is mounted.)

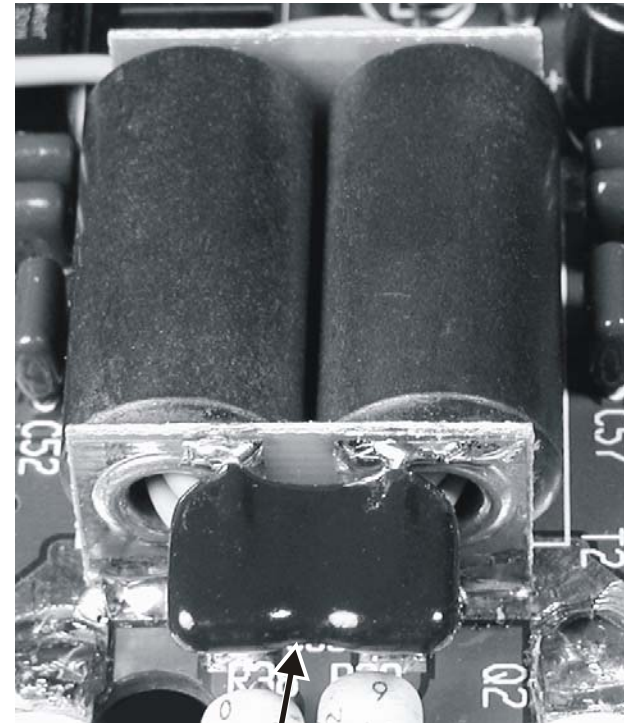

Position C83 as shown. See text.

Figure 31

 Figure 33 (page 41) shows wiring details for J1, J4, and J5. Refer to this illustration while completing the following steps.

- As shown in Figure 33, two types of 2-pin connector housings are supplied: 0.156" pin spacing for use at J1 and J4, and 0.1" spacing for J5. Also supplied are small and large crimp terminals (see parts list photos). Locate the smaller of the housings and two of the small crimp terminals for use at J5.

- Cut a 6" (15 cm) length of two-conductor speaker cable (small gauge, with clear insulation). Split the conductors at both ends, then remove 1/4" (6 mm) of insulation from the ends of all four wires. **Avoid nicking or tearing the wire strands when removing the insulation.**
- Twist each wire's strands together, then tin the wires, using a very small amount of solder (just enough to hold the strands together).
- Attach crimp terminals to the two wires at one end as shown in Figure 33 (Detail A). Before soldering, fold the small flaps of the terminal closed using long-nose pliers. This will hold the wire in place.



When you insert crimp terminals into the housing in the next step, they should snap into place. Each terminal has a small retaining tab on the back that latches into a hole in the housing. The location of the retainer and its hole in the housing are shown in Detail B.

- Figure 33 shows J5 with the wires attached, and the small guides on the connector facing down and away from you. Hold the connector in this orientation, then insert the **silver** wire into the **right** hole of the housing until it snaps into place. Insert the copper wire into the left hole. Verify that the retainer tab is locked in place (Detail B).
- Insert the wires at the other end of this cable into the pads labeled AF (silver wire) and GND (copper wire) on the KPA100 board. Insert the wires all the way up to the insulation to avoid leaving any exposed lead length. Solder both wires.
- Locate the two larger 2-pin housings and four of the large crimp pins for use at J1 and J4.
- Cut a 4.5" (11.5 cm) length of RG-174 coaxial cable. Using a sharp tool, remove about 3/4" (2 cm) of the coax jacket from each end (see Figure 32). Be careful not to nick the braid.



Figure 32

- Separate the braid (shield) from the center conductor at both ends. Clip off about half the strands of the braid close to the jacket, then twist the remaining braid into a thin bundle.
- Remove a small amount of insulation from the center conductor. Use long-nose pliers to hold the center conductor while stripping it.
- Solder the center conductor and shield to crimp terminals.
- Insert the terminals into a 2-pin housing as shown in Figure 33 (**center conductor** on the left, **braid** on the right).
- Solder the other end of the coax cable to the two pads labeled "RF IN" and "GND" on the KPA100 board (near relay K1). **The shield goes to "GND".**
- Cut two 4.5" (11.5 cm) lengths of #20 AWG stranded insulated hookup wire, one **red** and one **black**. Remove 1/4" of insulation from each end of both wires.
- Twist the strands together tightly, then tin the wires. **Use a very small amount of solder.**
- Solder one end of each wire to a large crimp terminal.
- Insert the terminals into a large 2-pin housing as shown in Figure 33 (**black** wire on the left, **red** wire on the right).
- Solder the free end of the **red** wire to the pad labeled "12 K2" on the KPA100 board. Solder the **black** wire to the nearby "GND" pad.
- Use two cable ties to secure the wires at the indicated locations.

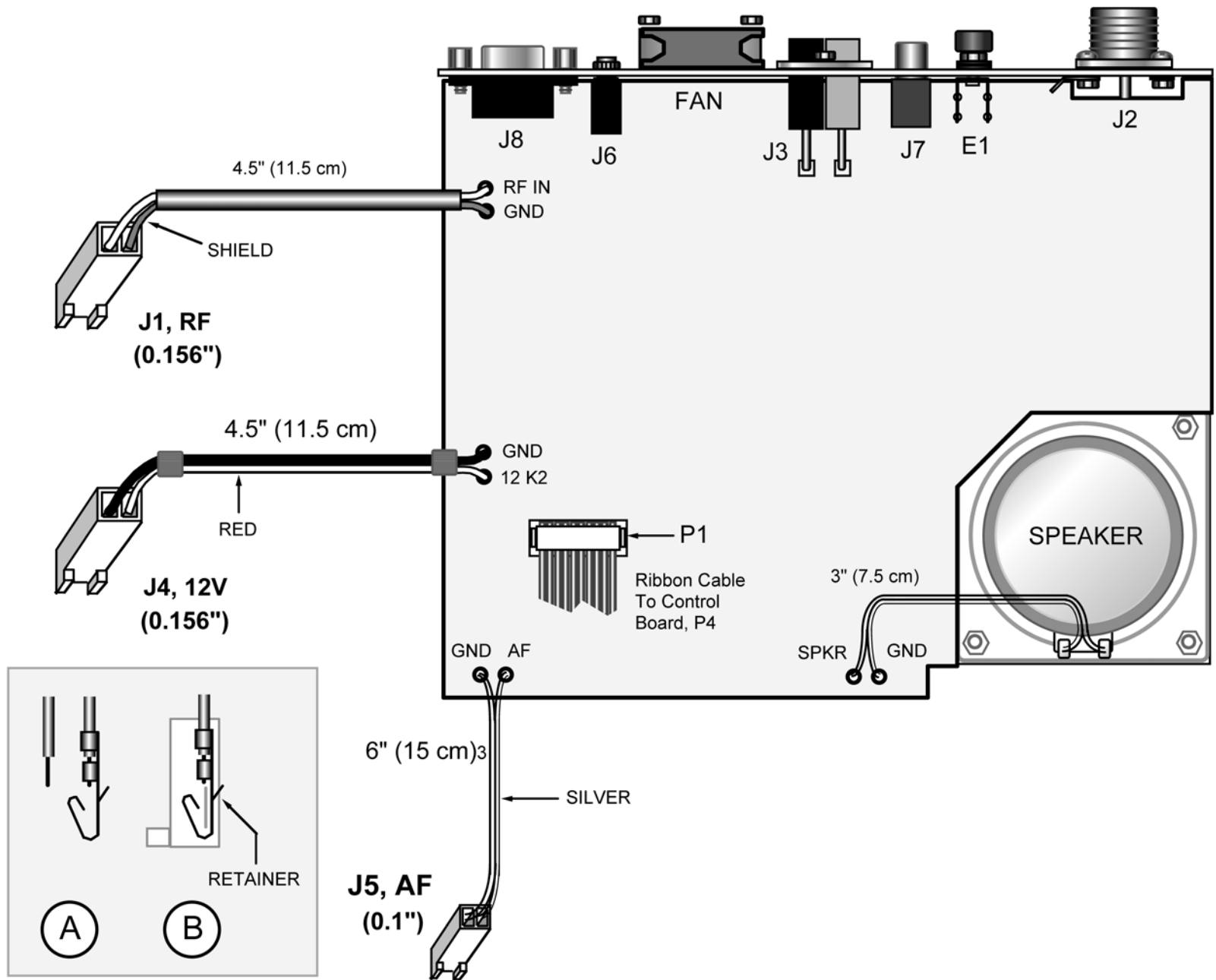

Figure 33

- The 12V and RF cables to the K2 use identical connectors. In the next section, a capacitor will be added to the RF board to prevent damage to components in the event that the cables are reversed. In addition to this, you should mark the 12 V connectors (KPA100-J4 and RF-P3) in some way to distinguish them from the RF connectors.
- Cut a 3" (7.5 cm) length of the 2-conductor speaker wire.
- Split the conductors out at each end. Remove 1/4" (6 mm) of insulation from all four wires, then twist and tin the strands using a small amount of solder.
- Near the speaker cutout on the KPA100 board you'll find two pads labeled "SPKR" and "GND". Solder the silver-colored wire to the pad labeled "SPKR", and the copper wire to "GND".

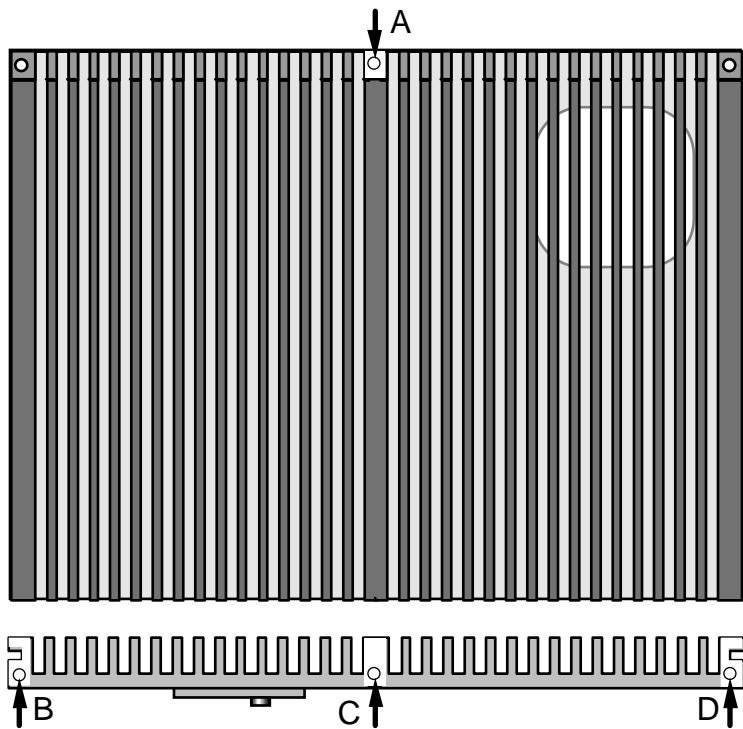

Figure 34

- At this point you should have no unfilled component locations except C82, L15 and R12. If others are unfilled, make sure no steps were missed.
- Unwrap the heat sink and place it on a soft, clean surface.
- Using sand paper, remove the heat sink's black finish at the four areas shown in white in Figure 34. **At point A, be very careful to sand only on the narrow shelf, not on the tops of the fins.**
- Trim the grille cloth to the same size as the speaker frame.
- Place fibre washers (black) on each of the heat sink's four speaker mounting holes. Cut just enough material off each corner of the grille cloth so that it fits between the washers, not touching them.
- Place the speaker on top of the grille cloth and fibre washers (Figure 35). Align the speaker frame with the front and side edges of the heat sink. **The speaker terminals should face the front, as shown in Figure 33 (previous page).**
- Secure the speaker using 4-40 x 3/16" (4.8 m) **black, flat head** screws (Figure 35.) Do not use lock washers.
- Locate the speaker shield. Remove the backing from the self-adhesive pad inside the shield (Figure 35). Install the shield over the speaker magnet, keeping it approximately centered.

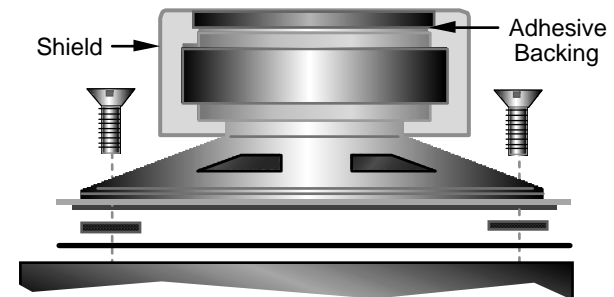

Figure 35

- Locate the two TO-126 thermal pads (rectangular, gray). Remove the adhesive backing, then attach them to the heat sink pedestal (adhesive side down) at the locations marked Q3 and Q4 in Figure 36. Center each pad over its associated hole.

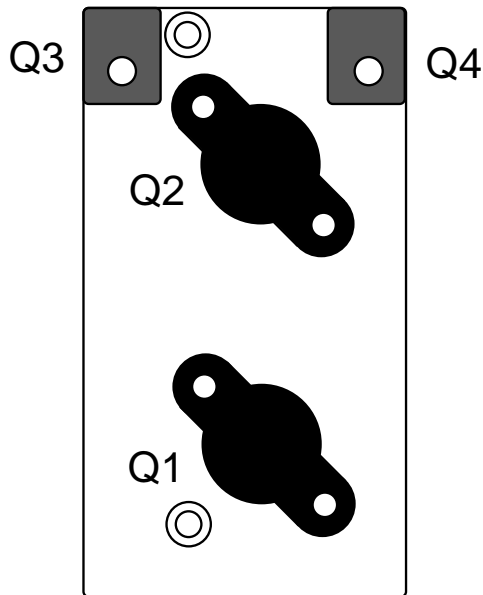



Figure 36

- Locate the thermal pads for Q1 and Q2. Remove the small punch-outs at the mounting holes in each pad, if still present. **Note:** these thermal pads do not have adhesive backing.
- Place thermal pads at Q1 and Q2 as shown above. Align the holes in the pads with the holes in the heat sink. **Do not omit these pads: the power transistors will be quickly destroyed without them.**
-  **Do not use lock washers between the heat sink and the PC board when attaching the board in the next step.**
- Install the PC board/rear panel assembly onto the heat sink. Press the board down until it is flat against all seven standoffs on the heat sink, including the two machined standoffs on the pedestal.

- Secure the rear panel to the heat sink using three 4-40 x 3/16" (4.8 mm) **black** pan head screws.
- Adjust the locations of the thermal pads for Q1 and Q2, if necessary, so that they are still aligned with the mounting holes.
- Secure Q1 and Q2 to the heat sink using 4-40 x 1/4" (6 mm) pan head screws and split lock washers. **Use a small-handled Phillips screw driver to fasten the hardware tightly without risk of over-tightening or stripping out the screw heads.**
- Secure Q3 and Q4 to the heat sink using 4-40 x 1/4" (6 mm) pan head screws and split lock washers. Use a small-handled driver as you did with Q1 and Q2.
- Look between the PC board and heat sink to verify that no component leads or bottom-mounted components are touching the heat sink or associated hardware.
- Place a #4 split lock washer over each of the seven set screws.
- Install 1/2" (12.5 mm) standoffs on the two set screws at the **front** edge of the board. One is near the "SPKR" and "GND" pads, and the other is near the "AF" and "GND" pads. **Do not over tighten.**
- Install 5/8" (16 mm) standoffs on the remaining five set screws.
- Unwrap the top cover panel. If masking tape (usually green in color) is present on the inside surface, you'll need to remove it. Use a ball-point pen to push on the tape through each hole until the tape lifts away. Then peel the tape off, using a sharp tool if necessary. Be careful not to scratch the outside surface of the panel.
- Install the top cover panel onto the narrow shelf at the front of the heat sink. Secure the panel using three 4-40 x 3/16" (4.8 mm) **black** pan head screws.
- Solder the speaker wires to the speaker. The silver wire should be soldered to the speaker's (+) terminal.

Alignment and Installation

i You will need two power supplies to complete testing of the KPA100: the low-current supply that you use with your K2 at the 10-watt level (3 amps minimum), and a 20-amp, 13.8 V supply for high power use. The instructions will specify when to connect each power supply.

Make the resistance measurements listed below, touching the DMM's (+) lead to the indicated points, and the (-) lead to ground. **Note:** The reading from J3 to ground may initially read a short (0 ohms) because of the large electrolytic capacitor on the 12 V line. Use a low resistance range, and wait up to 20 seconds for the reading to stabilize.

KPA100 Test Points (+)	Resistance
J3 + lead (red) (see note above)	> 5 k
Q1 collector	> 10 k
Q2 collector	> 10 k
Q1 base	11-16 ohms
Q2 base	11-16 ohms
J2 (antenna jack) center pin	> 10 k
Q9 tab (near rear panel)	> 10 k
D13 cathode (banded end)	> 10 k

Closely examine all of the cables on the left side of the KPA100. Make sure the crimp terminals are properly seated, and that there are no loose wire strands that might cause a short.

Locate two DC input connector housings, one red and one black. Hold the two connectors in the orientation shown in Figure 37. Look closely at the sides of the connectors. Each has a small tongue on the right side, and a groove on the left.

Slide the tongue on the right side of the **red** housing into the groove on the left side of the **black** housing. Make sure the housings are mated exactly as shown, with the black housing to the right and the "hoods" at the front of the connectors facing up. The interlocking tongue and groove must be fully meshed.

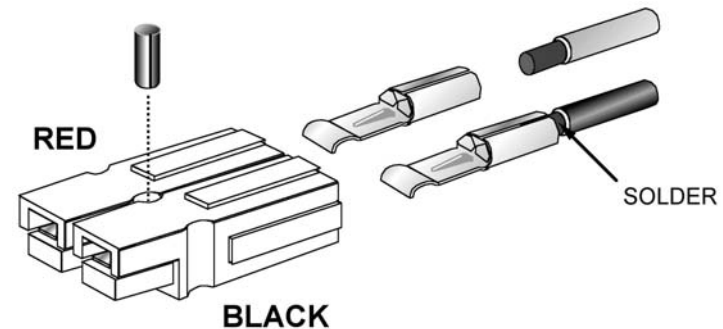

Figure 37

i Use only the supplied 12 AWG, 2-conductor stranded wire (red/black) for the DC power cable.

Separate the two conductors at one end of the 12 AWG, 2-conductor cable. Remove 5/16" (8 mm) of insulation from the red and black wires at one end. Do not nick or cut off any of the strands.

i Do not crimp the 30-amp terminals. They will be soldered in the next step, providing a reliable connection.

Insert the wires into 30-amp terminals as shown above. Solder the wires to the crimp terminals, using enough solder to completely surround the wire and fill the interior of the terminal. (This may take as long as 10 seconds if you're using a small iron.) Be careful not to get solder on the thin tongue that extends from the front of the terminal. It helps to tilt each terminal so the tongue is above the solder cup so solder cannot run onto the tongue.

Insert the terminals into the housings exactly as shown in Figure 37. The terminals should snap securely into place. Pull on the wires individually and make sure that they cannot be pulled out (if so, the terminals are probably inserted upside down).

Optional: The supplied spring pin may be used to keep the red and black housings from slipping apart (see above). The manufacturer of the connectors recommends gluing the pin in place with super-glue.

 **You should install the supplied fuse holder even if your 20-amp power supply has its own fuse or circuit breaker. This will allow you to use the K2/100 transceiver with an unfused power supply or battery if the need arises.**

At the far end of the DC power cable, clip the **red** wire at the point shown (Figure 38a). Peel away and save the short red wire.

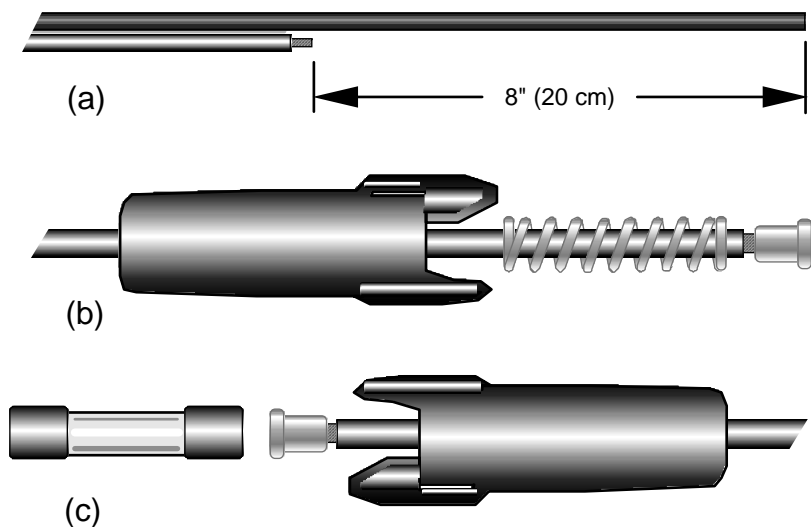

Figure 38

Peel the attached red wire back 3" (8 cm). Remove 5/16" (8 mm) of insulation from the end (Figure 38a).

Insert the attached red wire through a fuse holder half, as well as the spring (b). **Note:** If the wire won't fit into the fuse holder or spring, you may need to peel off the thin, clear sleeve over the insulation. To remove the sleeve, slit it lengthwise with a sharp tool, with the blade inserted between the sleeve and the insulation. Be careful not to cut into the insulation itself.

Solder the red wire to a fuse terminal.

Insert the 8" (20 cm) red wire through a fuse holder half. Remove 5/16" (8 mm) of insulation, then solder the wire to a fuse terminal (c).

Pull the terminals back inside the holder halves, and install the supplied fuse (c). Press the two halves together and twist to secure.

Prepare the free end of the cable as needed to match your 20-amp power supply connections.

 At the far right edge of the K2 RF board are connectors **P6** (Aux RF) and **P3** (Aux 12V). If you have not previously installed the KAT2 or KBT2 options, you'll need to install the supplied 2-pin, 0.156" spacing male connectors as described below. A DC blocking capacitor (**RF-Crf**) has also been supplied, which will be installed only if your K2 serial number is 2999 or lower.

If the 160-meter option is present, remove its one screw and unplug it. Leave it (and the RX ANT jack) attached to the heat sink.

Remove the K2's bottom cover (6 screws).

Remove the K2's heat sink/lower rear panel (6 screws, two 4-40 nuts, and the nuts on the antenna and key jacks). Save the thermal pads for Q7 and Q8, which may fall off when the heat sink is removed.

Install 2-pin male connectors at P6 and P3 as indicated by their outlines. **They must be oriented so that their plastic polarizing tabs are toward the front panel of the K2.** Solder P6 and P3.

- If your K2 serial number is 2999 or lower:** Install the supplied DC blocking cap (**RF-Crf**, .047 μ F) on the bottom of the RF board at the location shown in Figure 39. The indicated trace must be fully cut; verify that it is open using your DMM.
- Carefully examine all hardware associated with the PA transistors, Q7 and Q8, on the bottom of the RF board. If any of the plastic hardware or the thermal pads appears to be melted or damaged, you should order the **K2 PA Hardware Kit** from Elecraft.
- Re-install the heat sink/lower panel and any new Q7/Q8 hardware as described in Part III of the basic K2 assembly instructions. **Do not over-tighten any of the hardware.**
- Using a DMM on its lowest resistance scale, measure resistance from the collectors of Q7 and Q8 to ground. If you see a reading of less than 100 Ω , the heat sink may be shorted to one of the transistor tabs. Remove the heat sink and correct the short before proceeding.
- Re-install and secure the 160-meter module if applicable.
- Re-install the K2's bottom cover.

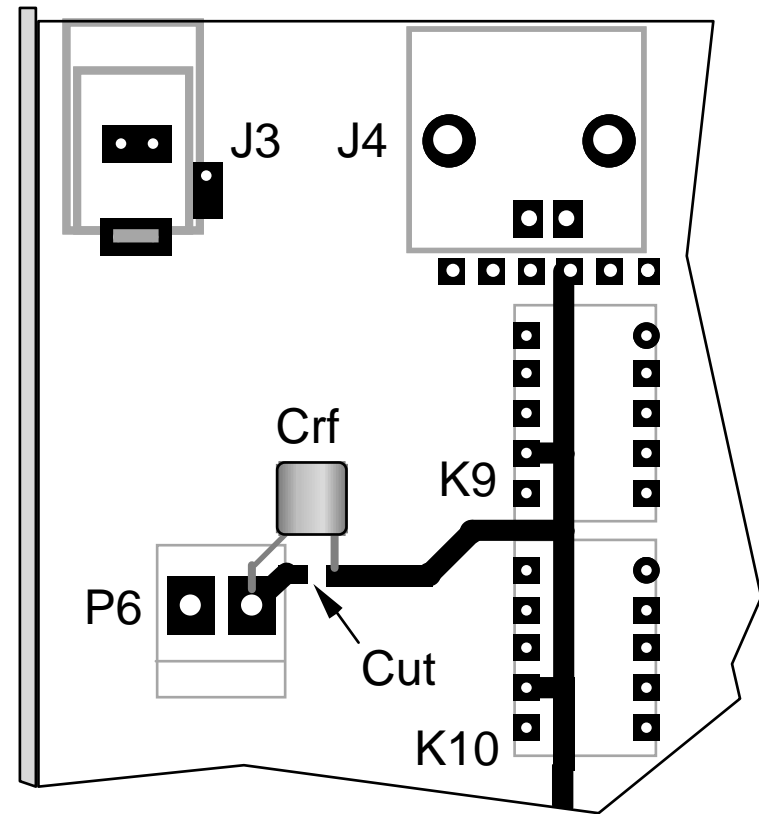

Figure 39

- Install the black rubber BNC connector cap on the K2's BNC antenna jack. **The BNC antenna jack will not be used once the KPA100 is installed. The antenna will be connected to the KPA100's SO239 jack instead, even when using low power.**

- Set the KPA100 upside down to the right of the K2 on a suitable platform, as you did earlier.
- Connect a low-current (3 amp minimum) power supply to the K2's DC barrel jack (RF-J3).
- Plug in the ribbon between the KPA100 and the K2 Control board.
- Turn on the K2. You should see the **NO PA PS** message as before, since no power supply is connected at KPA100-J3.
- Check the K2 current drain and voltage using the DISPLAY switch. Current should be about 100-200 ma higher than without the KPA100.
- Set your DMM for DC volts, **200 or 300 V full scale** (or auto ranging). Connect the DMM's (-) probe to the ground jumper on the KPA100 board (near U1). Using the DMM's (+) probe, make the voltage measurements listed below.

KPA100 Test Point (+)	Voltage
Junction of C77 and R11	90 to 150 V
U4 (MAX1406) pin 8	-5 to -25 V
TP1 (near Q2 and T2)	0 to 0.1 V
J3 + lead (red)	0 V



If you have any difficulty during the test or alignment steps that follow, refer to the **Troubleshooting and Repair** section of this appendix.

Receiver Tests

- Plug a pair of headphones into the K2's headphone jack. Turn on the K2 and adjust the AF GAIN control so that noise can be heard.
 - Plug the audio cable from the KPA100 (J5) into the K2's internal speaker jack (RF-P5). If this has any effect on the noise heard in the headphones, you may have a short in the wiring of J5.
 - Unplug the headphones. You should now hear noise coming from the KPA100's speaker. The sound may be reduced in volume (it will sound normal when the KPA100 is installed inside the K2). If the signal sounds distorted or very weak, check the wiring of the J5.
 - Plug the headphones (or a speaker) into the external speaker jack at the back of the KPA100 (J6). You should hear the same signal as before, and louder if you're using headphones. **Note:** If you're using stereo headphones, you'll only hear the signal in one ear.
 - Turn the K2 off.
 - Connect the KPA100's internal RF cable (J1) to the K2, at **RF-P6** (labeled "AUX RF"). **Do not plug J1 into RF-P3 ("AUX 12V").**
- Note:** Do not connect the KPA100's internal 12VDC cable (J4) to the K2 at this time.
- Turn the K2 on.
 - Connect an antenna to the KPA100's SO239 antenna jack (J2). Verify that you hear signals or atmospheric noise on *all* bands. You should hear relays switching on the KPA100 as you change bands.

Note: The low-pass filter relays on the KPA100 will switch at different bands than those on the K2 RF board. On the KPA100, 30/40, 17/20, and 10/12/15 meters each share a single low-pass filter.

The signal from the KPA100's 4-MHz crystal oscillator (X2) may be audible at the high end of the 80-meter band. If this is the case, you can move it to a point just above 4 MHz using trimmer C27. The signal from the 4-MHz oscillator on the K2 Control board may be much stronger. Rotate C27 slightly to identify the KPA100 signal.

SWR Bridge Null Adjustment (C1)

Connect a 50-ohm dummy load rated at 5 watts or higher to the KPA100's SO239 antenna jack (J2).

Select the 40 meter band (7000-7300 kHz). Set the K2's POWER control for about 5 watts.

Temporarily remove power from your K2/100 and set the FWD and REFL potentiometers on the KPA100 (R26 and R27) for about 43K ohms resistance measured between the center arm and ground.

Set the SWR null trimmer (KPA100-C1, near the antenna jack) so that its adjustment slot is *perpendicular* to the KPA100 rear panel.

Note: With the KPA100 installed, the TUNE mode display includes both forward power and SWR. For example, **5.0 1.0-1** means 5.0 watts, output, and an SWR of 1.0:1.

Locate a small insulated-handle screwdriver or tuning tool, and prepare to adjust C1 on the KPA100. Enter TUNE mode by holding **TUNE**. Adjust C1 for an SWR indication of **1.0-1** on the K2 LCD. Cancel TUNE mode by tapping or holding **TUNE** again.

Note: You'll see an indication of **1.0-1** over a small range of C1's rotation. Position C1 at approximately the middle of this range, repeating the TUNE adjustment several times if necessary.

Optional SWR fine adjustment

You may be able to adjust C1 more accurately by measuring the reflected voltage directly using a DMM or an analog voltmeter. Connect the (-) lead to the ground jumper on the KPA100 board (near U1). Touch the (+) lead to TP4 near pin 1 of KPA100-U5 (LM358). Repeat the TUNE

procedure from above, adjusting C1 for a reading as close as possible to zero volts on the voltmeter.

8R Menu Setting

The **t-r** control must be set to **8r hold** when the KPA100 is installed. To check the setting, tap **MENU** and locate **t-r** by turning the VFO knob or pressing the **BAND+** or **BAND-** buttons. Hold **EDIT** to enable the **t-r** function, then tap **DISPLAY** to toggle between **8r nor** and **8r hold**. Be sure **8r hold** is selected, then tap **MENU** twice to exit the menu function.

Power Calibration (R26 and R27)

Connect an external wattmeter between the KPA100 antenna jack (J2) and the 50-ohm dummy load.

Select the 40 meter band (7000-7300 kHz). Set the POWER control for 5.0 watts.

Note: This calibration step can be done later at a higher power level if your wattmeter doesn't have an accurate low-power scale.

Locate a small flat-blade screwdriver and prepare to adjust R26 on the KPA100. Enter TUNE mode on the K2. Adjust R26 for a power indication on the K2 LCD that matches the reading of the external wattmeter. Cancel TUNE mode. Repeat as needed until the K2's LCD shows the same power level as the external wattmeter.

Set R27 to exactly the same position as R26 (visually). This will provide adequate accuracy for SWR readings.

Check the SWR in TUNE mode on every band. The SWR should be close to 1.0 to 1 on all bands (**1.0-1**).

Temperature Calibration and K2 Current Limit Set

Turn the KPA100 bias control, R6, fully counter-clockwise.

Tap **MENU** to enter the K2 menu, then scroll to the **CAL** menu entry. Hold **EDIT** to highlight the **CAL** parameter. Select **CAL tPA** (KPA100 temperature calibration). Then hold **EDIT** again to activate the **CAL tPA** function.

Using the VFO knob, adjust the temperature shown on the LCD to match the room temperature in **degrees C** (Celsius). To convert Fahrenheit to Celsius, subtract 32, then multiply the result by 0.55.

Tap or hold **MENU** to exit **CAL tPA**.

Select and activate the **CAL CUR** menu entry. Set the current limit to **3.50** amps if it was set lower than this. This should prevent any **HI CUR** warnings when driving the K2/100 to full power.

KPA100 Power Supply Test

In following tests, you'll connect both your low-current and high-current power supplies to the K2 in different combinations. This will test the K2's *dual-supply* capability, which is useful for emergency-power situations. For example, if a 12 volt battery is kept float-charged and connected to the K2's low-current DC input jack, the transceiver can be operated at the 10- to 15-watt level even if the power mains go down or the high-current supply fails.



Do not key the transmitter during these tests.

Turn the K2 **off**. Disconnect the low-current power supply.

Make sure your high-current power supply is turned **off**.

Connect the high-current supply (20 A) to KPA100-J3.

Connect the KPA100's internal K2 DC cable (KPA100-J4) to the K2's Aux 12V input (K2-P3, on the RF board).

Rotate the K2's POWER control fully counter-clockwise.

Turn your high-current supply on. The K2 should remain off.

Check your high-current supply's voltage and current drain, if it has built-in metering. The voltage should be the same as its no-load voltage (nominally 13.8V). The current should be nearly zero.

Turn on the K2. You should **not** see a **NO PA PS** message, since you do have a power supply connected to the KPA100.

Check the K2's voltage and current using the **DISPLAY** switch. The voltage indicated should be the same as the high-current power supply's voltage, less about 0.3 to 0.5 volts (the voltage drop across diode KPA100-D9). The current should be about 100-200 mA higher than with the KPA100 removed.

Tap **MENU**, then tap **DISPLAY** to access the secondary menu. Scroll to the **PA** menu entry, then hold **EDIT** and change the parameter to **OFF**. Exit the menu.

Verify that the POWER control range is 0.1-15 watts.

Use the menu to set the **PA** parameter to **ON**. Exit the menu.

Verify that POWER can now be set in 0.5-watt increments up to 10.0 watts, and 1-watt increments from 11 to about 110 watts. Below 11 watts, the KPA100 will be in "bypass" mode. You should hear the bypass relays on the KPA100 (K1 and K2) switch at this point.

Turn the K2 off. Also turn off your high-current power supply.

Leaving the high-current power supply connected, but turned **off**, connect the low-current power supply to the K2's normal DC input jack (barrel connector, RF-J3).

Turn the K2 ON. After **ELECRAFT** is shown on the LCD, you should see the message **NO PA PS**. POWER range will be 0.1-15 W.

Turn the high-current power supply on. You should see **PA PS ON**. POWER range should again be 0.1 to 110 watts.

Turn the high-current power supply **off**. After 1 to 10 seconds, should see **NO PA PS**. The delay depends on how long it takes for the high-current power supply to drop to about 8 volts.

- Turn the high-current supply back on.
- Turn off and disconnect the low-current power supply.** It should not be used during the remaining tests.

Fan Test

- Set the **POWER** control for **11** watts or higher.
- Edit the **PA** menu parameter. Tap **DISPLAY** until you see **FAN nor** (normal). The fan should *not* be running.
- Tap **DISPLAY** again to set the fan mode to **FAN LoHi**. The fan should switch to low speed, which should be barely audible.
- Tap **DISPLAY** to select **FAN Hi**. The fan should switch to high speed. Tap **DISPLAY** to return to **FAN nor**. Exit the menu.

External Amplifier Keying Test (PA KEY)

- Use the MODE switch to select CW mode (mode letter changes to C). Enter CW TEST mode by holding **VOX**. The letter **C** should now be flashing. In this mode, the K2 will not put out any power when you key the rig either with a key or with the TUNE switch.
- Set your DMM to its lowest resistance scale. Connect the (-) probe to ground, and touch the (+) probe to the tab of Q9 on the KPA100 board (or to the center conductor of the PA KEY output jack, J7).
- The DMM should be indicating a high resistance (typically indicated by a flashing display). Hold **TUNE** on the K2 to key the transmitter. The resistance reading should drop to less than 3 ohms.
- Tap any switch to exit TUNE mode. Exit CW test mode by holding **VOX**. The mode letter will stop flashing.

Bias Current Adjustment



This is the most important KPA100 alignment step. If your 20-amp power supply does not have accurate current measurement capability in the 0-1 amp range, you'll need a DC milliammeter to set the bias current. Most DMMs have a suitable high-current range. A full-scale range of about 1 amp (1000 mA) or higher is required, with resolution of 0.02 amps (20 mA) or better.

- Turn the K2 **off**.
- Turn the high-current power supply **off**.
- As a precaution, connect a dummy load (any power rating) to the KPA100's antenna jack (J2). This will protect the transmitter in the event that bias is set too high or the transmitter is keyed.
- Rotate R6 on the KPA100 (Bias Set) fully **counter-clockwise**.
- If you're using a DMM to make the current measurements, set it to a 1 amp or higher range. **Your DMM may have a separate high-current tip jack. Consult the DMM's manual before using it.**
- The DMM must be inserted in series with the positive lead of the DC power cable.** Connect the (+) lead of the DMM to the power supply side of the circuit, and the (-) lead to the KPA100 side.
- Turn on the high-current power supply, then turn on the K2. Using the menu (secondary), make sure that the **PA** menu entry is set to **ON**. Exit the menu.
- Use the MODE switch to select CW mode (mode letter changes to C). Enter CW TEST mode using **VOX** (the letter **C** should flash).
- Rotate the POWER control on the K2 through its full range (0.1-110 watts), then set it to 0.1 watts (fully counter-clockwise). The DMM (or other current meter) should show about 200-400 mA, depending on how you have the K2 configured.

- Set POWER for 11 watts. The current should increase by about 200 mA (150 mA for the KPA100 T-R switch, and 50 mA for the fan, running at low speed). Record the new total: _____ mA. Finally, add 400 mA (200 mA per power transistor) to this to determine the target reading for bias setting: _____ mA.
- Prepare to adjust R6 on the KPA100 (Bias Set). Make sure you're in CW TEST mode (mode letter **C** flashing).
- Enter TUNE mode, then adjust R6 clockwise until the current meter shows approximately the target current recorded above. The current may slowly drift higher, but R6 should be left at a setting that provides the target current when you first enter TUNE mode.
- Exit TUNE mode by holding any switch.
- Turn the K2 off, then turn off the high-current power supply.
- Disconnect the DMM and any clip leads you used for current measurement. If you moved your DMM's (+) lead to a different tip-jack on the meter for high-current measurement, return it to the normal (+) jack.

Transmit Tests

- Connect a 100 watt dummy load to the KPA100 antenna jack (J2). **Avoid using an antenna for initial transmit tests.**
- Make sure the high-current power supply is connected to the KPA100 and is turned on.
- Turn the K2 on. If you're using an antenna, switch to the band it is resonant on, and locate an unused frequency.
- Set the POWER control for about 5 watts. The KPA100 will be in bypass mode (disabled). Select the 40-meter band.
- Enter TUNE mode for a few seconds (maximum) and make sure that the K2 (and external wattmeter, if any) indicates about 5 watts.

- Select CW mode using the **MODE** switch. Using another ham-band receiver or transceiver, listen to your signal while sending CW.
- Set the POWER control for 20 watts. You should hear the relays on the KPA100 switch into high-power mode at the 11-watt point.
- Enter TUNE mode for a few seconds (maximum) and make sure that power output is about 20 watts. **Note:** The power may rise gradually to a few watts above the intended level, the drop back slightly below it. This is normal ALC behavior, and may happen more than once as the power transistor bias stabilizes during key-down.
- Listen to the signal quality in the second receiver while keying. The 20-watt signal should be stronger than the 5-watt signal, but the quality of the keying and sound of the signal should be identical.



To protect the power transistors from high SWR, TUNE mode initially limits power to 20 watts. To override, hold **TUNE** and **DISPLAY** together, or turn the POWER knob after TUNE starts.

- Test the KPA100 at your dummy load's rated power, up to 100 watts. Limit key-down time to a few seconds. **Note:** If you're using an antenna, and the SWR is too high for a given power level, the K2/100 will automatically reduce power. You'll see **HI REFL** on the LCD.



If you see HI CUR on the display, or if current drain seems to be too high on several bands, you may have R26 and R27 misaligned due to the use of an inaccurate external wattmeter. (Your actual output may be well over 100 watts.) Re-align using an accurate wattmeter, or turn both potentiometers slightly clockwise to stay within safe limits.

- Key-down current drain is typically 12-18 amps at 100 watts, depending on the band. You can confirm this easily if your power supply has current metering. An alternative is to measure the DC voltage across the current-sensing resistor, R7. Every 5 millivolts of voltage across R7 equals one amp of Q1+Q2 collector current. So, for example, a reading of 0.090 V across R7 would equal about 18 amps.

Optional: If you want to re-do power calibration (R26/R27) at a higher power level, do so now. 50 watts is a good choice.

Check output capability, signal quality, and current drain on the remaining bands.

SSB Mode Transmit Tests (Requires KSB2 Option)

Switch to USB or LSB mode. Connect a microphone to the K2.

Set the compression level (SSBC) to 1-1 using the menu. This turns off speech compression, allowing you to better hear your voice quality in the next step.

Using headphones with the monitor receiver, listen carefully to your SSB signal at both 5 watts and 20 watts. If the signal quality is good in both cases, with no sign of distortion, try higher power levels (up to 100 watts or the rated power of your dummy load).

Before you go "live" in SSB mode, you should make sure that you've properly aligned your K2/100 transceiver's filters for USB and LSB transmit. SSB transmit filter alignment (that is, adjustment of the BFO settings for FL1) can be done by listening critically in a monitor receiver, or with the help of a station nearby, or by using a computer spectral analysis program. Refer to the KSB2 manual or our web site for additional information.

RS-232 Port Test

If your K2 is s/n 2999 or lower, you must modify your Control board as described on page 59 before the RS-232 port can be used. If you have already made this modification, skip to the next step.

We recommend that you build a serial cable and complete RS-232 interface tests now, before installing the KP100. (See **RS-232 Interface Setup and Test** on page 60.) However, if you don't plan to use computer control right away, you can do the tests at any time.

Shield Assembly

Turn off the K2.

Locate the KPA100 shield and the three spring clips (see drawings in the parts list).

Orient the shield as shown in the top view of Figure 40 (page 53). The top and back edge views in the figure show the proper orientation of the spring clips, which will be installed in the next step.

Install spring clips at the locations identified by the letter *C* in Figure 40. As shown by the dotted lines, the clips should be installed on the bottom side of the shield. Use 4-40 x 3/16" **black** pan head screws, 4-40 nuts, and split lock washers. Do not over-tighten the hardware.



The lock washers go between the nuts and the spring clips, not between the spring clips and the shield.

Each clip should be perpendicular to the edge of the shield, and extending beyond the edge by about the amount shown. If necessary, loosen the hardware slightly and adjust the positions of the spring clips so that they closely match the drawing. Then re-tighten the hardware.

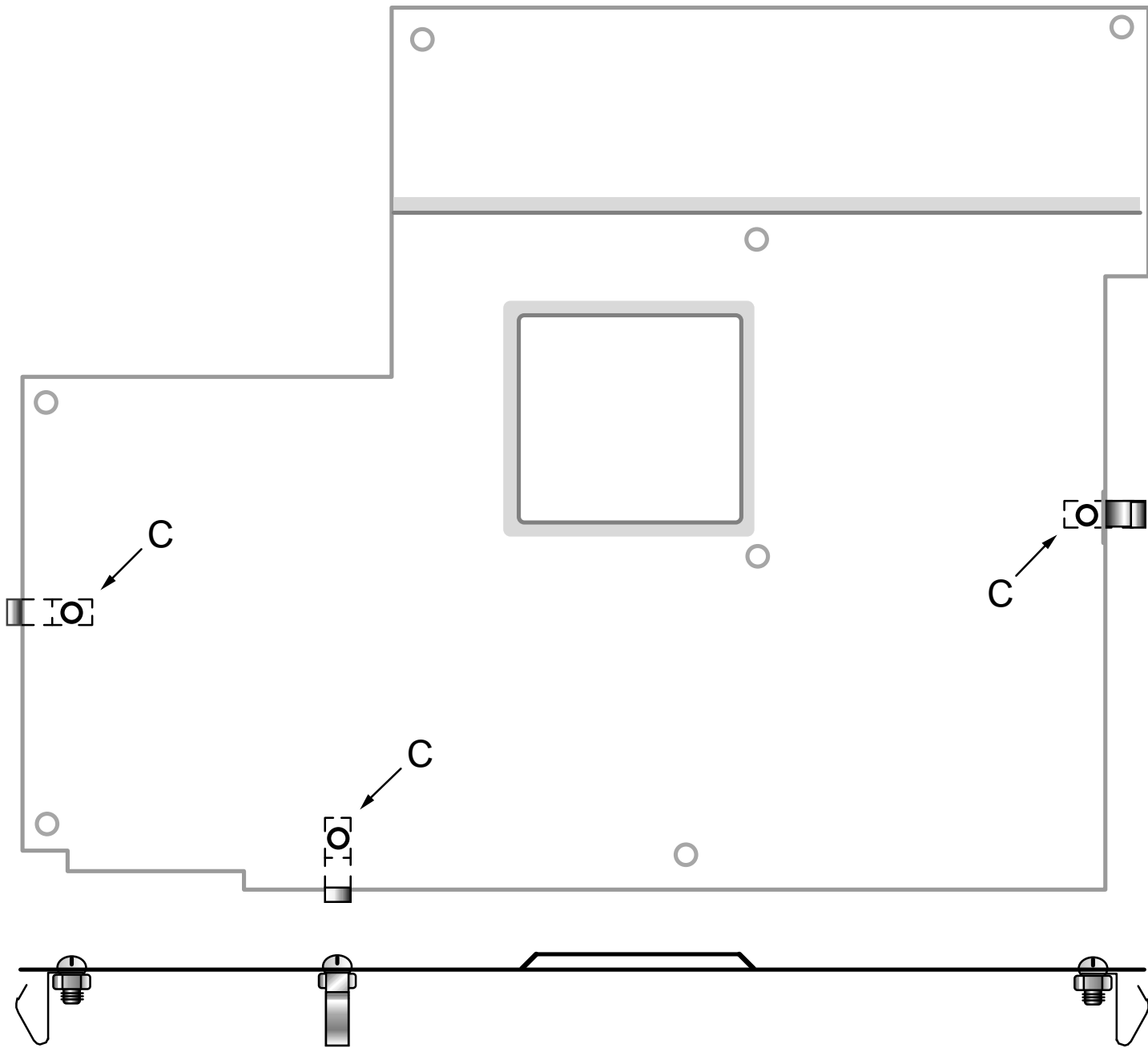

Figure 40

- Verify that the two standoffs at the front edge of the KPA100 board are 1/2" (12.7 mm) tall. The others should be 5/8" (16.9 mm).
- Make sure that the 4-MHz crystal, X2, does not have any solder on the top of the can. If the ground wire was installed on the top, it must be moved to the side of the can, and all solder removed from the top using desoldering braid. Otherwise the shield will not fit correctly.
- Place the shield assembly onto the KPA100. The three spring clips on the shield should face downward (toward the KPA100 PC board). The spring clip in the rear should be touching bare metal at the inside of the rear panel. When the shield is aligned with the 7 standoffs, this spring clip should be slightly compressed.
- If the shield doesn't lay flat against all of the standoffs, it may need to be straightened. If you do attempt to straighten it, be careful not to bend any of the spring clips.
- Secure the shield assembly to the standoffs using 4-40 x 1/4" (6 mm) pan head screws and split lock washers.

- The two remaining solder lugs will be used to form a ground strap between the shield and rear panel as shown in Figure 39a. Attach one lug to the shield screw nearest the SO239 connector. The lug replaces the lock washer, which can be saved as a spare.
- Attach the second lug to the upper-right of the four screws holding the SO239 connector to the rear panel. This lug also replaces the original lock washer.
- Using long-nose pliers, fold the second lug down at a 90-degree angle so that it overlays the first as shown below. Trim the excess length off the end of the first lug.
- Solder the two lugs together.
- Tighten the hardware to ensure good contact at both ends of the ground strap.

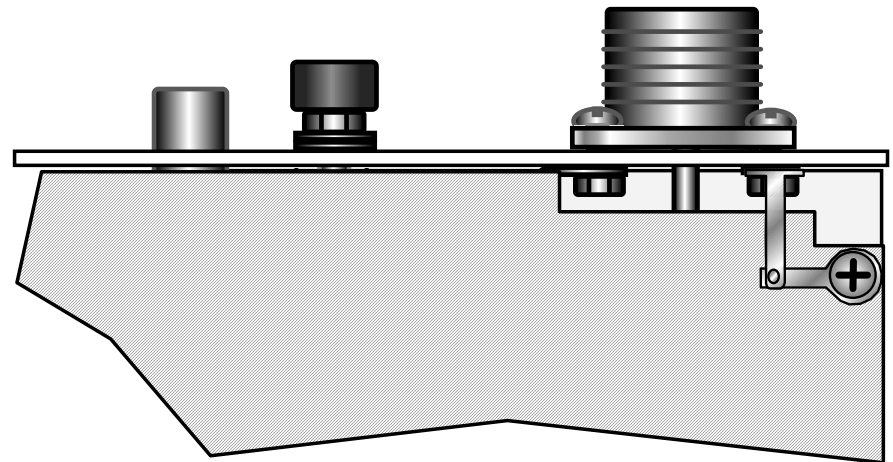

Figure 39a

KPA100 Installation

- We recommend disconnecting the K2's internal frequency counter cable when the KPA100 is installed. Leaving this cable connected may cause a slight increase in the amplitude of spurious signals on some bands. Keep the cable in a safe place for later use.
- Turn the KPA100 assembly over carefully and install it in the K2. Make sure that the left and right spring clips don't get caught on the top edges of the side panels. Also verify that none of the interconnecting cables are pinched between the heatsink and side panels. (Final cable positions will be adjusted in later steps.)
- Secure the KPA100 to the K2 only at the four locations identified as **1**, **2**, **5**, and **6** in Figure 10 (page 23). Use 4-40 x 3/16" **black** pan head screws. Do not install the remaining two screws yet.
- Remove the right side panel of the K2 (four screws).
- Examine the cables connecting the K2 and KPA100. Move the ribbon cable and speaker cable toward the front of the K2. They should not be touching the KSB2 or KNB2 modules, if present.
- Hold the right side panel up to the K2, and note where the KPA100 shield clip contacts the panel. Mark this spot with a pencil.



Be sure to mark the *inside* of the panel. When you're looking for the spring clip contact point, four of the five side panel screw holes should line up with 2-D fasteners. The fifth screw hole, at the top-middle of the side panel, should line up with the grooved channel on the KPA100 heat sink.

- Lay the side panel on a soft cloth. Using sand paper or a Dremel tool (or equivalent), remove the paint from around the marked location so that the spring clip will make good contact. Paint should be removed from an area about 1/4 to 1/2" (6-12 mm) in diameter.

- Remove the left side panel. Mark the shield clip contact point, then remove the paint from this area as described above.
- Attach the side panels to the K2 (five screws each). The top center screws are threaded into the aluminum heat sink. Do not over-tighten these screws. It is possible to strip the threads in the aluminum.

Final Steps

- If you plan to use the KPA100's RS-232 port for remote control of the transceiver, follow the instructions starting on page 59.
- Read the entire section titled **Using the K2/100 at High Power**, starting on page 56, before putting your K2/100 on the air.
- IMPORTANT: The hardware holding the RF power transistors in place will loosen slightly during initial use. After 5-10 hours of normal operation at 50 watts or more, remove the KPA100 assembly and its shield, then re-tighten the mounting hardware for Q1/Q2 approximately 1/8 turn.**

Using the K2/100 at High Power

Power Supply

Dual-Supply Capability

There are *two* DC input jacks on the K2/100: a low-current DC barrel jack on the lower rear panel, and a high-current Anderson Power connector on the upper rear panel (KPA100). The low-current DC input is for a 4 amp (minimum) power supply that can power the K2/100 in QRP mode (up to 15 W). The high-current input is for a 20-amp power supply that allows operation at up to 100 watts.

If a high-current supply is connected, you can still connect an emergency backup power supply or battery at the low-current input. If the high-current supply fails, the K2/100 will immediately drop into bypass mode and continue running from the backup supply.

Two special status messages are provided in the case where two supplies are connected. If you turn off just the high power supply, you'll see **NO PA PS** (may take up to 10 seconds due to slow decay of the power supply voltage). If you turn the high-power supply back on, you'll see **PA PS ON**. The K2/100 will go in and out of bypass mode when the high-current supply is turned on and off.

High Current Power Supply Requirements

The high-current power supply should be rated at **20 amps** or higher. *Switching* supplies are compact and inexpensive, but generate noise that may be heard in the ham bands if you use wire antennas with little or no feedline. If noise is a problem, use a *linear* supply.

The DC input jack on the KPA100 assembly, J3, is not switched. This means that 12-14VDC will appear on the KPA100 board anytime your high-current 20A supply is turned on. This is typical of most compact HF transceivers, and should not present a problem. The current drain from this power supply with the K2 turned off should be very low.

CAUTION: Keep the K2/100 at least 18" (0.5 m) away from all equipment that uses large power transformers. AC hum from transformers may cause modulation of the transmitted signal that can be heard on the air.

Antenna

Transmit/Receive Antenna Jacks

The K2/100 has two transmit/receive jacks: a BNC jack on the lower rear panel, and an SO239 on the upper rear panel (KPA100). The BNC connector is provided with the basic K2 for use at up to 15 watts. The SO239 is the standard connector for higher-power operation.

If the KPA100 is installed, you should use only the SO239 antenna jack. The BNC antenna connector should be kept covered by the supplied rubber cap.

Receive Antenna

If you have the K160RX option installed, you'll have a separate receive antenna jack (BNC) on the lower rear panel. This input can be enabled on a per-band basis using the **RANT** menu entry.

Ground

A ground thumbscrew is provided on the upper rear panel (KPA100).

Antenna and Antenna Tuner Considerations

The K2/100 can be used with coax-fed antennas or antenna tuners. In either case, SWR should be kept as low as possible. High reflected power (caused by high SWR) will result in an automatic reduction of power output by the transceiver. This is required to protect the power transistors. When the K2/100 reduces power due to high SWR, you'll see the message **HI REFL** on the K2's LCD.

When an antenna tuner is being adjusted, it can present a very wide range of impedances to the power output stage. For this reason, initial tune-ups should be done in QRP mode (10 watts or less). Use only that amount of power required for your tuner to operate correctly.

Note: If the POWER control is set above 20 watts, power will be temporarily set to 20 watts when you hold **TUNE**. This can be overridden by holding **TUNE** and **DISPLAY** together.

Controls

High Power Configuration and Fan Control

High power (QRO) operation is controlled by the **PA** menu entry in the secondary menu. Tap **MENU** to bring up the primary menu, then tap **DISPLAY** to select the secondary menu (**SEC** will flash on the LCD). Next, scroll to the **PA** entry using the VFO knob or **BAND+** / **BAND-**. To edit the **PA** parameter, hold **EDIT**.

The **PA** parameter has four possible settings:

- **OFF** puts the K2 in QRP mode (POWER range 0.1-15 W)
- **ON** is the normal setting (see **POWER Control**, below)
- **Fx.xx** shows the KPA100 board's firmware revision
- **Exxx** shows KPA100 error status, if any (see Troubleshooting)

While editing, tap **DISPLAY** to change the KPA100 **fan mode**:

- **FAN nor** is the normal setting; the fan stays off until needed
- **FAN LoHi** keeps the fan at low speed, going to high if needed
- **FAN Hi** keeps the fan at high-speed at all times in QRO mode

Note: In all fan modes, the fan will switch to high speed at a heat sink temperature of about 40 degrees C. It will turn off within 2 to 4 minutes after going back below 37 degrees C.

To exit parameter edit, tap **MENU** once. You can optionally tap **DISPLAY** again to return to the primary menu (**PRI** will flash). Tap **MENU** a second time to return to the normal frequency display.

POWER Control

If **PA** is set to **OFF** in the menu, or if the high-current supply is missing, the POWER control range will be 0.1 to 15 watts. The 10 bargraph LEDs show output up to 10 W (1 watt per LED bar).

If the **PA** is set to **ON** and a high-current supply is connected, the POWER control covers 0.1-110 watts. The lower third of the control's rotation provides 0.5-watt increments up to 10 watts (1 watt per LED bar). The upper two-thirds of the control's rotation provides 1-watt increments from 11-110 watts (10 W per LED bar). The bypass relays on the KPA100 will switch at the 10-watt point.

Front-Panel Switches

RF/ALC: RF or ALC meter mode. Use only for test, not continuously.

ANT 1/2 Selects one of two antennas on the Elecraft KAT100 ATU.

TUNE Puts the K2/100 into tune (key down) mode at no more than 20 watts. Can be overridden by holding **TUNE** and **DISPLAY** together.

PA KEY Output (KPA100, J7)

The PA KEY output can key an external amplifier's T-R relay. The "8R HOLD" keying option must be enabled when using the PA KEY output. See *8R Menu Setting* on page 48 for details.

Temperature Calibration (CAL tPA)

See page 48 for PA temperature sensor calibration instructions.

Other Important Operating Information

Transmit Warning Messages

If SWR is too high, you'll see **HI REFL** on the LCD. If current is too high, you'll see **HI CUR**. In both cases, power will be reduced as needed. **PA HOT** indicates an unsafe heat sink temperature; tap any switch to clear the message. After correcting the problem, you'll need to reset output to the desired level using the POWER control.

Excluded Frequency Range

Transmit is disabled from 25.000 to 27.999 MHz in QRO mode.

CW Operation

In CW mode the power output may rise to a few watts beyond the intended level, then drop back slightly below it. This is normal ALC behavior, compensating for gain change as amplifier bias stabilizes.

8r Hold Required

8r hold function must be enabled when transmitting with the KPA100. See *8R Menu Setting* on page 48 for instruction on how to ensure 8r hold is enabled.

Data Mode Operation

The maximum recommended power for PSK31 mode is 40 W, and for higher duty cycle modes such as MFSK, 25 W.

Remote Control using the RS-232 Port

Control Board Preparation

If your K2 serial number is 3000 or higher, or if you have previously installed a KIO2 option in your K2, skip the steps on this page and continue with *RS-232 Interface Setup and Test* on page 60.

- Turn off the K2. **Before handling the Control board in the following steps, touch a grounded surface.**
- Remove the screws that hold the K2 Control board to the front panel board. Also remove the audio filter module if present.
- Use the long-handled Allen wrench supplied with the K2 to pry the Control board up at the point marked "LIFT HERE" on the RF board. Place the Control board in front of you, component side up.
- Figure 41** shows the *bottom* side of the Control board, where most of the changes will be made. One trace will be cut on the *top* side.

The trace between Q5-gate and U6 pin 25 must be cut as shown below. **This trace is located on the top side of the Control board.** Once you have located the trace, use a sharp tool such as an X-acto knife to make two small cuts near the location marked with an "X". Press *down* with the tip--don't draw the knife *across* the trace, since you may slip, cutting adjacent pads or traces. Next, pry up and remove the small segment between the cuts. Examine the trace closely to make sure the cut segment is completely removed.

Cut a 3/4" (19 mm) length of the supplied green-insulated hookup wire, and remove 1/8" (3 mm) of insulation from each end. Install and solder this jumper on the bottom of the board, between Q5-gate and U8 pin 4, as shown below. Make sure the jumper doesn't contact adjacent pads or component pins.

Solder a .001 μ F, 0.2" LS capacitor ("102") across P4, pins 1 and 5. (Listed as **Ctxd** in the parts list.)

Prepare a 4" (10 cm) jumper using hookup wire. Solder it between U6 pin 25 and P4 pin 1 on the bottom side of the board (pin 1 is the round pad). Make sure the jumper doesn't touch adjacent pins.

Re-install the Control board (and KAF2 if applicable)

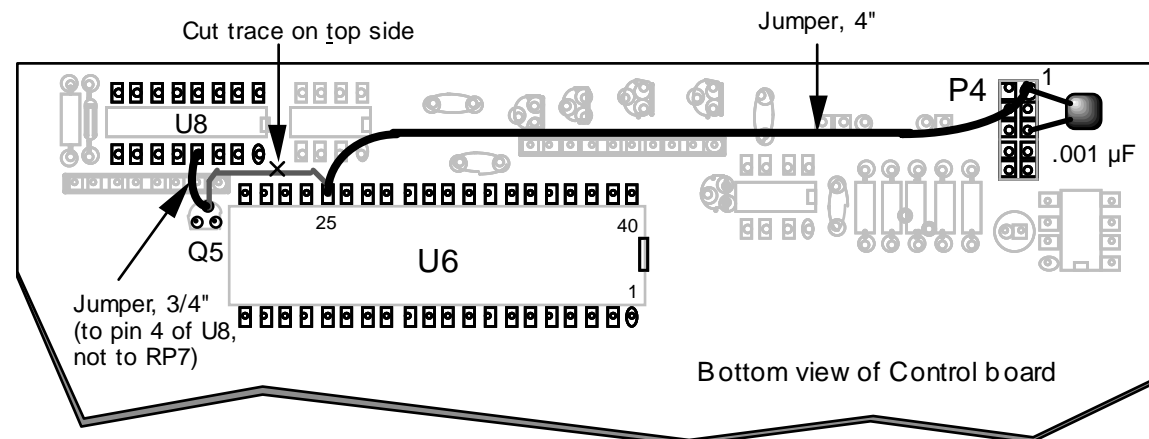



Figure 41

RS-232 Interface Setup and Test

- Connect the KPA100 to the K2 Control board via the ribbon cable (see page 25). Also connect the KPA100 speaker cable (J5) to the K2 RF board.
- Connect a low-current power supply to the K2's DC power input jack (lower rear panel).
- Turn on the K2.
- Tap **MENU** and locate the **ST L** (sidetone volume) menu entry, then hold **EDIT** to edit the parameter. If no sidetone is heard (due to the Control board modification), tap **DISPLAY** to change the sidetone source to **U8-4** (default is **U6-25**). If you still don't hear the sidetone, refer to Troubleshooting. Tap **MENU** twice to return to the frequency display.
- Turn off the K2.

KPA100 to Computer Cable Assembly

 **CAUTION: Do not use a pre-assembled cable of any kind (printer cable, etc.) between the KPA100 and a computer.** Some of J8's pins provide special signals not intended for use with an RS-232 interface, and you could damage the K2, KPA100, or the computer if these lines are used incorrectly.

- Locate the 4-conductor cable. The cable can be cut to a shorter length if desired, but it will work equally well at its full length (10', 3 m).
- Remove 1/2" (12 mm) of the jacket from the cable. Be very careful not to nick the individual wires.
- Peel back and cut away the foil shield.
- The white wire will not be used for serial communications, but should be saved as a spare. Fold it against the cable jacket and secure it with tape.
- Strip off 3/16" (5 mm) of insulation from each insulated wire.

- Twist the strands of each wire together and tin them lightly with solder.
- Locate the DB9F (female) and DB9M (male) connectors. Arrange them as shown in Figure 42 (male connector on the right, solder cups facing up). Make sure the 5-pin rows are facing each other.
- Clamp the DB9F (female) connector into a padded vise, if available.
- As shown in Figure 42, pins 7 and 8 of the female connector can be wired together (using a discarded component lead) to provide RTS/CTS loop-back². Some software requires this *hardware handshaking*. We recommend that you make this connection, unless you're sure that your application software does not need it. Some programs use these lines for CW keying, etc.
- Clip the bare shield wire off **at the PC end of the cable only**. The shield wire will be connected at the K2 end.
- Solder the RED, GREEN, and BLACK wires of the PC end of the cable (the end with no shield wire) to the female connector. Refer to Figure 42.
- Remove the female connector from the vise, and insert the male connector. Keep this connector in the orientation shown.
- Solder the BARE (shield), RED, GREEN, and BLACK wires to the male connector as shown.
- Remove the male connector from the vise.

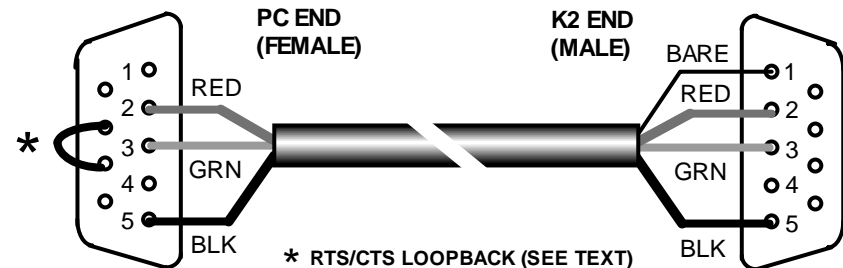

Figure 42

² RTS = Request to send, CTS = Clear to send.

Locate the connector housings (backshells) and associated hardware. **Note:** A single hinged backshell may be provided rather than a two-piece backshell.

Attach a backshell to the male connector (Figure 43). Use the provided cable clamp to hold the cable in position, then secure the clamp with two screws. (A one- or two-piece clamp may be supplied.) The jackscrews must be retained by the shells. Secure the backshell halves with the provided hardware (or, if the shell is hinged, snap the backshell closed).

Attach a backshell to the female D connector.

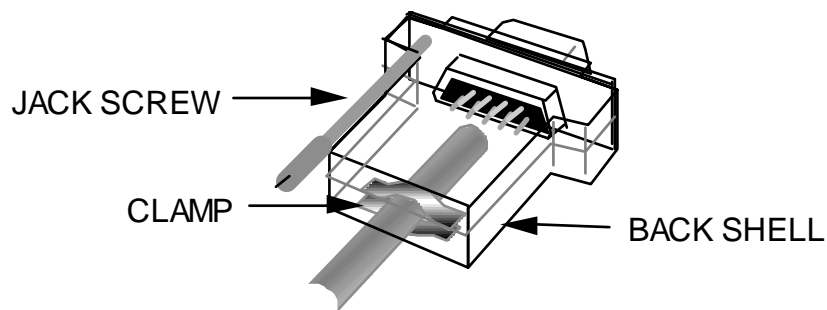

Figure 43

Serial Interface Test

Connect the serial cable to the KPA10 (J8) and to the computer. Use a 9-pin to 25-pin adapter if required. Secure the cable at the computer using the jackscrews.

Turn on the K2 and computer.

Tap **MENU**, then tap **DISPLAY** to gain access to the secondary menu.

Locate the **PORT** menu entry using the **BAND+** and **BAND-** switches. To edit the parameter, hold **EDIT**, then change it from **OFF** to **ON** (using **BAND+** / **BAND-**). Tap **MENU** twice to exit.

You can use your logging or control program to verify that basic operations such as band or mode change are working. (See **Software Configuration**, following page.)

An alternative is to use a terminal program such as Hyperterminal:

- Run the terminal program. Set it up for 4800 baud, 2 stop bits (1 will also work), 8 data bits, no parity. Turn off hardware handshaking (RTS/CTS). If possible, turn on *local echo* and *line-feed* so you can see what you type.
- Tap **MENU** and locate the **PORT** menu entry as you did earlier. Hold **EDIT** to enter edit mode.
- Tap **DISPLAY** to send a test message from the K2 to the computer. A string of characters similar to **FA00014020000**; (VFO A frequency).
- Tap **MENU** twice to exit the menu.
- At the computer keyboard, type **SW01**; (the semicolon is required). This should cause the K2 to switch to the next higher band. **Note:** You cannot backspace and correct errors. Incorrect commands will be ignored.

If the K2 did not transmit and/or receive data as described above, or did not work properly with an application program, refer to **Troubleshooting**.

Computer Control

Computer-Generated Noise Considerations

Computers, their power supplies, and their peripherals can generate HF-range spurious signals. If you use coax-fed antennas, you may not hear any noise. However, if you use a wire antenna with a short feedline (or no feedline), you'll almost surely hear *birdies* or hash on some bands when the computer is on.

If computer-generated noise is a problem, you may have to improve your ground system, re-orient your antenna, move the antenna farther away, or use coax feed.

Software Configuration

The KPA100 is intended to be compatible with a wide range of existing PC-based logging, DXing, remote control, and contesting applications. However, we cannot guarantee 100% compatibility. In general, software used with the K2 should be set up as follows:

Radio Type: Elecraft K2³

Interface: 4800 baud, 8 data bits, no parity, 2 stop bits (1 will also work)

Handshaking: Set to "None" if possible. No hardware handshaking is required.

Polling: Many programs periodically *poll* the radio to see if the operator has manually adjusted any of the controls. The K2 can respond very quickly to these requests, but we recommend a setting of 1-3 seconds to minimize possible computer noise. Polling during transmit is allowed, but we recommend turning it off if possible.

Table 1 provides details on setting up selected remote control and logging software for use with the K2. Check our web site additional information. Also available on the web is the *Elecraft KIO2 Programmer's Reference*, which you can consult when writing your own K2 control programs. The KPA100 and KIO2 serial interfaces are functionally identical.

Using Elecraft's K2REMOTE and K2VOICE PC Software

K2REMOTE provides flexible remote control of the K2, even over the Internet (using TCP/IP). K2VOICE is a voice feedback program for the K2 which make the K2 fully usable by hams who are unable to see the normal K2 controls and displays. You can download the programs and associated documentation from our web site.

³ If your software does not list the K2, select the TS-570D or the closest equivalent (950, 850, 50). The K2 can recognize a large subset of TS-570 commands. (TS-570 is a trademark of the Kenwood Corporation.)

Table 1. Application software information.

Program	K2 Configuration and Operating Notes
CT	DOS program; requires a batch file to start up correctly (for details see http://www.k1ea.com/hintkink.htm). In the batch file, use the command COMTSRx -Px -B4800 -N82 (e.g., x = 1 for COM1) Set Radio 1 to TS950 if K2 is not in the list. Optional: change bands from the K2 manually the first time so CT can store the values for VFO A and VFO B for each band.
DX4WIN	Use K2 or Kenwood (generic) radio type, 4800 baud. Default polling rate is 6000 msec with 6 retries, but 1000-2000 msec is recommended. Clicking on a DX spot may set the wrong mode. Don't use multiple-band scanning, since this could cause excessive relay wear.
DXBASE	Use Elecraft or Kenwood radio type.
K2REMOTE, K2VOICE	See descriptions on previous page.
Log-EQF, Rig-EQF	A modified rig file for these programs that better supports the K2's RTTY and RTTY-reverse modes can be found on our web site.
MixW	Version 2.02 and later includes K2 support (listed under Kenwood)
NA	Run the "CONFIG" program. Select F4 (Serial Port Setup). On the desired port, set baud to 4800, and set device to XCVR1. Select F5 (Equipment Configuration). Set XCVR #1 to KENWOOD1 Run NA. Go to the Equipment Control Panel and check Radio #1.
RCP570	TS-570 emulation; some controls not applicable to the K2. The program can take up to 30 seconds to turn on the radio display on start-up. Don't use SEND button (hangs the computer).
T-R Log	In the configuration file (.cfg), set: RADIO ONE TYPE = TS570 (Version 6.63 and later: use K2) Also add SHIFT KEY ENABLE = TRUE to use the right and left SHIFT keys to change the receive frequency when RIT is on. Hitting both shift keys simultaneously resets the RIT to zero.
TRX Manager	RTS/CTS loop-back required at computer end (pin 7 to 8).
WriteLog	Check the "Poll" box, and select <u>N</u> o for "Comm PTT".
YPLOG	Specify 2-wire mode (RxD/TxD, no handshaking). Note: The program may send the K2 "FL" filter selection commands, which are not supported.

CW Keying and PTT

There are three basic ways to key the K2 when using a computer:

- **Microphone, hand key, or paddle directly to the K2:** This is preferred if you don't use the computer to generate CQs and contest exchanges.
- **Serial or parallel-port control line keying:** Many programs support this method. In SSB mode the computer turns a selected control line on to activate PTT. In CW mode, the computer generates the dots and dashes, turning the selected control line on and off in response. The control line(s) used--which may be at RS-232 or TTL/CMOS levels--must be level-shifted for connection to the K2 key and/or mic jacks.
- **"Virtual" keying, using computer commands sent to the KPA100's serial port:** In this case, no connection to the key or mic jacks is required for keying the K2. In SSB mode, the computer sends the K2 "TX" and "RX" commands, which the K2 responds to by turning PTT on and off internally. In CW mode, the computer sends typed characters to the K2 using a "KY" command, and the K2 converts the characters to dots and dashes internally. This method of keying is supported by only a few remote-control applications, including Elecraft's K2REMOTE program. (For details on the TX, RX, and KY commands, refer to the KIO2 Programmer's Reference.)

For control-line keying, you can use the spare wire (white) in the 4-conductor cable. You'll need to connect this wire to the specified control line at the PC end. At the K2 end, a level converter using an NPN transistor will be required (usually diagrammed in your program's user manual). The white wire must then be brought out from the connector at the K2 end and routed to a 1/8th inch stereo plug for the key jack. You can optionally use two diodes (or two transistors) to take advantage of the K2's "auto-detect" feature, allowing both the computer and a keyer paddle to be connected to the K2's key jack at the same time. Additional information on this topic can be found on our web site.

Connecting Other Equipment to the KPA100

J8 provides a number of signals in addition to those needed for the RS-232 serial interface (Table 2). **Note:** Use pin 1 as the electrical ground for any external devices. Pin 5 should only be used as the RS-232 ground return to the computer.

Table 2. J8 Signal Descriptions.

Pin	Signal	Notes
1	Chassis GND	RF/DC ground
2	TxD	RS-232 data from K2 to computer
3	RxD	RS-232 data from computer to K2
4	--	Not connected
5	RS-232 GND	RS-232 ground return
6	AuxBus	K2 configuration network, intended for use with AuxBus-compatible peripherals. Connections made to this line must be shielded, and total bypass capacitance should be between .001 and .005 μ F.
7	RF Detect	RF level feedback (DC), intended for use with an external automatic antenna tuner. Improper use of this line could result in incorrect K2 power settings, high current, or other difficulties.
8	12CTRL	This is intended as a power-on signal from the K2, and/or for powering low-current external peripherals. Total load current should be kept under 50 mA continuous, 80 mA peak. A 150- Ω or larger series current limiting resistor should be used.
9	8 V Receive	8 V on receive, 0 V on transmit (approx.) This signal is intended for use sequencing external amplifiers, although the use of the PA KEY output is preferred because it can drive amplifier relays directly.

K2/100 Specifications

All measurements were made using a 13.8 V, 20-amp power supply and 50-ohm load. Numeric values are typical; your results will be somewhat different. Specifications are subject to change without notice. (Note: specifications in section 2 of the K2 owner's manual apply to the KPA100 except where superceded here.)

Weight	5 pounds
Supply voltage	11 to 15 VDC, 13.8 V nominal
Current drain,	
Receive ⁴	PA OFF (QRP mode): 0.2-0.4 A PA ON (QRO mode): 0.3-0.5 A
Transmit ⁵	15-20 A typ. @ 100 watts
Frequency ranges	Same as K2, except 25-27.999 MHz transmit is excluded in high-power mode
Power output	0.1 to 100 W, adjustable
Spurious emissions	Better than -40 dB @ 100 W
Harmonic content	Better than -40 dB @ 100 W ⁶
Cooling	2-speed fan ⁷

⁴ These figures reflect the total current drain in receive mode. The current drain indicated on the K2's LCD in voltage/current monitor mode will be lower because some circuits on the KPA100 are powered from the KPA100's DC input jack. For details, see the Operation section of the this manual.

⁵ Current varies with band, supply voltage, configuration, and load impedance. External 20-A in-line fuse required if power supply does not include a fuse or circuit breaker.

⁶ Frequency counter cable removed. Adding the cable with the PA installed slightly increases spurious content on some bands. Keep the cable to the shortest possible length if it is installed (about 6").

⁷ The fan control circuit should not be used to directly drive a supplemental external fan.

Key-down time	At full power (100 W), 10 sec max. recommended
Keying	Full break-in, diode switched
PA KEY output ⁸	
Compatibility	DC relay coil, pulled to ground (do not use with AC-controlled relay)
Current	1 A
Voltage	+200 VDC, maximum.
RS-232 interface	
Data rate	4800 baud
Format	8 data bits, no parity, 2 stop bits
Handshaking	None required
ESD protection +/- 15 kV	
Speaker	
Internal	4 ohm, 3 watt, shielded
External	Rear-panel mono jack

⁸Select "8R Hold" operation in the K2 menu as described under *8R Menu Setting* on page 47.

Troubleshooting and Repair

This information is specific to the KPA100 board. For other K2 troubleshooting, see Appendix E of the K2 owner's manual.

If your symptoms are not covered here, do a complete visual inspection of the board. Look for reversed diodes, leads not soldered (or not clipped), backwards ICs, and broken wires or components. Re-do all measurements from earlier sections, and test diodes in-circuit. Check continuity between the *pads* of all toroids (not the leads).

Table 3 and **Table 4** provide voltages on all diodes, transistors, and ICs. Start with receive-mode (RX) measurements, then transmit-mode (TX) at low power (0-10 watts), and finally 11-110 watt TX mode. Be sure to observe all notes and cautions listed in the tables. If you do signal tracing, keep power set low to avoid damaging your RF probe.

Replacing KPA100 firmware: If you upgrade your KPA100 firmware by replacing U1 (16F872), you must re-do the temperature calibration step (**CAL tPA**) on page 48. (The temperature calibration constant is stored in U1's on-chip EEPROM.) **Note: Do not set the bias control to zero when setting CAL tPA. This would disable temperature measurement capability.**

Replacing the power transistors (Q1, Q2): If you need to replace the RF power transistors, use only a matched set (request the Elecraft K2/100 PA Replacement Kit). Do not remove the old power transistors until you have read the instructions provided with this kit; you may damage the PC board.

Receiver problems

Noise: If you hear wide-band noise, or noise at certain frequencies, especially noise that drifts in frequency, it may be caused by your power supply. Switching power supplies and computers often cause EMI across the HF spectrum. This will be noticeable if you use end-fed antennas with little or no feedline. The cure may be to use a linear power supply, relocate your computer, or switch to coax-fed antennas.

Loss of signals on all bands: If you don't hear anything on *any* band, or if all signals are generally attenuated, you may have a problem in the KPA100 T-R switch or SWR bridge. Also check relays K1-K2.

Loss of signals on some bands: If you're missing signals on some bands but not all bands, look for a problem in the low-pass filter section. An inexpensive antenna analyzer can be very helpful. First, turn on the K2 and switch to the affected band, with POWER set for 10 watts or less (PA bypassed). Next, disconnect the RF cable running from the KPA100 to the K2, and insert a 47 or 51-ohm resistor into the 2 holes of the connector at the end of the coax cable (J1). Finally, connect an antenna analyzer to the KPA100's SO239 jack, and look at the SWR while sweeping the frequency across the band. If the SWR is poor, it probably indicates a problem with that low-pass filter.

Transmitter problems

HI CUR message: The K2's 10-watt stage is drawing too much current. Set **CAL CUR** for at least **3.50** A. Check KPA100 T-R components, R21-R22, T1, and nearby components.

HI REFL message: Flashed once per **TUNE** or band change if SWR is high. The K2 reduces power until reflected power is at a safe level.

PA HOT: This message indicates high heat sink temperature (85 deg. C), or that you have installed new KPA100 firmware without doing **CAL tPA** (see at left). Tap any switch to clear the message. After correcting the problem, reset output level with the POWER control.

Excessive current from high-current supply: If the supply current exceeds 20 amps on one or more bands, you may be putting out more than 100 watts due to using an inaccurate wattmeter during calibration. Or you may have a problem with the associated low-pass filter(s).

Power output low: If power output is somewhat low across all bands, it may be because you used an inaccurate wattmeter during calibration of R26/R27. Other possibilities include incorrect bias adjustment (R6), reversed or poorly-prepared leads on T4, or a T-R switch problem (check D11-D14 and their voltages during transmit). If power is low on some bands, check the low-pass filters as described under **Receiver Problems**, above. Also note that many watt meters read too low on 160 meters even if they read correctly on the other bands.

Key clicks: If your K2 s/n is 4059 or lower, you should install the K2 keying bandwidth mod (order #K2KEYMODKT). Also, some older linear amplifiers have slow-switch relays that can cause clicks.

KPA100 Error/Status Codes

The "Exxx" PA menu setting can show up to 3 single-digit error/status codes. Normally there will be none ("E "). The following codes are used, alone and in combination:

1: PA is in QRP (bypass) mode. Usually appears with code 2 ("E12").

2: No 12V power supply connected to the KPA100. Usually appears with code 1 ("E12").

4: The SWR became very high during transmit at or near full power, typically because of a sudden change to an ATU setting or a shorted/open antenna connector. This causes the K2 to reduce power to zero and show "Hi Refl" on the LCD. The error code can be cleared by rotating the POWER control. (Applies to KPA100 firmware rev. 1.04 or higher.)

7: The heat sink temperature reached 85 degrees C. This causes the K2 to reduce power to zero and show "PA Hot" on the LCD. Both the warning message and the E7 error code can be cleared by tapping any switch, then rotating the POWER control (repeat if necessary). The fan will remain on high until the heat sink temperature has dropped back below 37 degrees C. (Applies to KPA100 firmware rev. 1.04 or higher.)

8: This code will always be seen after setting CAL TPA, but it can also indicate a problem with the KPA100 MCU or its on-chip EEPROM. If it's just the CAL TPA indication, it can be cleared by turning power off and back on.

Codes 3, 5, and 6 are not presently used.

Miscellaneous

PA menu parameter missing: Make sure KPA100-U1 is not installed backwards, and has no bent pins. Check all U1 voltages (see DC voltage tables). Also check the KPA100-to-K2 ribbon cable.

INFO messages: If you see **INFO 080** or a similar message on the LCD, refer to the K2 Owner's Manual, Appendix E.

END message: This usually indicates that you are out of band.

Note: Transmit at high power is excluded between 25 and 28 MHz.

Fan stays on HIGH: If the fan remains at high speed for more than 4 minutes after you stop transmitting, the amplifier transistors may be getting too hot. You may have the bias pot (R6 on the KPA100) set too high. Also check voltages in the bias circuitry. If these all check out OK, chances are that Q1 and/or Q2 have been damaged and will need to be replaced. Another possibility is that **CAL tPA** has not been properly calibrated (see page *Temperature Calibration and K2 Current Limit Set* on page 48).

Missing 90-150 volt bias voltage or (-) RS-232 driver voltage: The most likely cause of this is a poorly prepared lead, or reversed leads, on T3. Next, check diodes D1-D8. These are located on the bottom of the PC board, but you can reach their pads from the top.

RS-232 I/O problems: Loss of K2 to computer data communication is often caused by a broken or poorly-soldered I/O connection, or by incorrect setup of the computer program. Verify the baud rate (4800) and related settings at the computer, and make sure the **PORT** menu entry in the K2 is set to **ON**. Your software may require the CTS/RTS loopback. Also, some PC programs work only under DOS, or require extra serial port configuration steps. Some versions of Hyperterminal prevent local character echo even if the appropriate box is checked.

Missing sidetone: The Control board modification changes the source of the sidetone to pin 4 of U8. The K2 needs to be configured to recognize the new source as explained under *RS-232 Interface Setup and Test* on page 60.

Exxx status information: The **Exxx** parameter, which is one of the **PA** menu entry settings, may be useful in troubleshooting. It can show up

to 3 one-digit status codes, alone or in combination. For example: **E1**, **E12**, **E478**, etc. The status codes are: **1**: PA is in QRP mode. **2**: No power supply is connected to the high-current DC jack. **4**: SWR became very high during transmit at or near full power. **7**: Heat sink temperature

was over 85 degrees C. **8**: Always appears after setting **CAL tPA**. If it cannot be cleared by turning power off/on, it may indicate a problem with the KPA100 MCU.

Table 3. KPA100 Diode DC Voltage Chart.

Ref.	Anode	Cathode	Ref.	Anode RX, 0-10w	Anode RX, 11-110w	Anode TX, 0-10w	Anode TX, 11-110w	Cathode RX, 0-10w	Cathode RX., 11-110w	Cathode TX, 0-10w	Cathode TX, 11-110w
D1	17	100	D11	14.1	1.5	13.9	1.6	14.0	14.0	13.9	0.8
D2	66	17	D12	14.1	1.5	13.9	1.6	119	0.8	115	113
D3	15	66	D13	14.1	1.6	14.1	See Note 1	14.1	14.0	14.0	See Note 1
D4	29	15	D14	14.1	1.6	14.0	See Note 1	117	0.8	116	113
D5	14	29									
D6	13.8	14.1									
D7	-17	-0.25									
D8	-0.25	0.0									
D9	14.1	13.8									
D10	0.0	14.1									

Note 1: Caution – High RF voltages may be present

Important: The voltages shown are actual measurements made on a properly working KPA100. Variations of up to 10% of the value shown due to power supply voltage differences and component tolerances are to be expected.

Table 4. KPA100 Transistor and IC DC Voltage Chart

Band=40m, DC supply voltage 14.1 VDC; Power level 11w or greater; High Current PS connected and powered on.

Important: The voltages shown were actual measurements made on a properly working KPA100. Variations of up to 10% of the value shown due to power supply voltage differences and component tolerances are to be expected.

Ref.	Pin	VDC	Ref.	Pin	VDC	Ref.	Pin	VDC	Ref.	Pin	VDC	Ref.	Pin	VDC
Q1 RX	E	0.0	Q1 TX	E	0.0	Q12	G	13.8-0	U2	5	0.0	U5	1	0-10
	B	0.0		B	0.57	Note 2	S	0-4		6	0.0	Note 1	2	0-10
	C	14.1		C	14.1		D	0-4		7	0.0	“	3	0-10
Q2 RX	E	0.0	Q2 TX	E	0.0	U1 RX	1	5		8	0.0		4	gnd
	B	0.0		B	0.57		2	0.0		9	gnd	“	5	0-10
	C	14.1		C	14.1		3	0.0		10	13.8	“	6	0-10
Q3 RX	E	0.0	Q3 TX	E	0.0		4	0.0		11	13.5	“	7	0-10
	B	0.0		B	0.57		5	0.0		12	13.5		8	13.8
	C	0.0		C	0.0		6	nc		13	13.8	U6	1	nc
Q4 RX	E	0.0	Q4 TX	E	0.67	Note 2	7	4		14	13.8	Note 1	2	0-4
	B	0.45	Note 3	B	1.35		8	gnd		15	13.8	“	3	0-4
	C	14.1		C	13.5		9	1.8		16	13.8		4	gnd
Q5 RX	E	0.0	Q5 TX	E	0.3		10	2.4		17	0.7		5	nc
	B	0.0	(100w)	B	0.8		11	5		18	13.8	“	6	0-4
	C	14.1	(100w)	C	13.3	Note 3	12	0, 5	U3	IN	13.8		7	5
Q6 RX	G	5	Q6 TX	G	0.0	RX, TX	13	5, 0		OUT	5		8	5
	S	0.0	(100w)	S	0.0	RX, TX	14	0, 5		gnd	0.0	U7	1	0-8
	D	0.6	(100w)	D	115		15	0.0	U4	1	13.8		2	14.1
Q7 RX	G	0.0	Q7 TX	G	5	RX, TX	16	0, 5		2	0.0		3	14.1
	S	0.0	(100w)	S	0.0	Note 3	18	0, 5		3	13.8		4	gnd
	D	14.1	(100w)	D	0.6		19	gnd		4	0.0		5	0.68
Q8 RX	E	0.0	Q8 TX	E	0.0		20	5		5	-22		6	0.68
	B	-2.5*		B	-2.5*		21	0.0		6	0.0		7	0.4-1.4
	C	7-15		C	7-15		22	0.0		7	13.3		8	14.1
Q9 RX	G	0.0	Q9 TX	G	5		23	0.0		8	-22			
	S	0.0@		S	0.0@		24	0.0		9	0.0			
	D	0.0		D	0.0		25	4.9		10	0.0			
Q10 RX	G	0.0	Q10TX	G	5		26	0.0		11	5			
	D	0.0	Note 3	D	0.0	RX, TX	27	5.7,<0.3		12	5			
	S	0.0		S	0.0	U2	1	0.0		13	5			
Q11 RX	G	0.0	Q11TX	G	5		2	4.9		14	0.0			
	D	0.0	Note 3	D	0.0		3	0.0		15	5			
	S	0.0		S	0.0		4	0.0		16	5			

* = approximate and/or may fluctuate; @ = depends on ext. amp control voltage; **Note 1** = depends on FWD/REF cal and SWR; **Note 2** = depends on 12PA supply voltage; **Note 3** = depends on Power level, 0-10w or >10w.

Circuit Details

Sheet 1

D11-D14, Q6, Q7, and related components form a high-isolation, full break-in T-R switch. D12 and D14 are forward-biased in receive mode; D11 and D13 are forward-biased in transmit mode. The "off" diodes are reversed biased by the high-voltage bias supply (90-150 V), preventing RF leakage across the inactive path. In QRP (bypass) mode, relays K1 and K2 route RF around the T-R switch, and both the transmit and receive diode paths are turned off to reduce current drain.

R21-R22 and C66 form an equalization network that reduces the required drive power on higher bands while increasing them on the lower bands. This keeps the overall frequency response of the power amplifier relatively flat from 160-10 meters.

Matched PA transistors Q1 and Q2 are conservatively rated at the 100-watt power level. They are operated in push-pull, providing a high degree of even-order harmonic suppression. U7B and Q4 supply bias. Q4 is an emitter follower, and U7B provides closed-loop regulation of the voltage at the emitter of Q4. Q3, attached to the heat sink, provides temperature feedback, reducing bias at high temperatures.

R7 and U7A form a current-sensing circuit. This is used by the microcontroller (U1, sheet 2) to check for excessive current drain.

L16, and C64 form a high-pass filter that helps ensure amplifier stability. Its cutoff frequency is 1.5 MHz. The output of the high-pass filter is routed to the low-pass filters (sheet 2) via D13 and C79.

Following the low-pass filters is the forward/reflected power bridge (T4, D16, D17). Rectified DC voltage from the bridge is buffered by voltage followers U5A and U5B. U6 further buffers the VFWD voltage (forward power) and drives the VRFDET line, which is returned to the K2 for purposes of closing the ALC loop (for power control).

In low-power (QRP) mode, Q10 and Q11 are turned off (high impedance), allowing the full voltage from the bridge to reach the associated A-to-D converter inputs on the microcontroller. In this case, the bridge performs identically to the one in the KAT2 ATU.

In high-power (QRO) mode, Q10 and Q11 are turned on by the SCALE line from U1. This pulls RP1 pins 2 and 3 to ground, which, in combination with R24 and R25, divides the VFWD and VREFL voltages by approximately 3.16 (square root of 10). Since KPA100 power output is proportional to the square of the voltage at the VRFDET line, this in effect scales power up by a factor of 10.

Sheet 2

Microcontroller U1 acts as a relay driver for the low-pass filter and bypass relays, and also gathers data from the SWR, current, 12V supply, and temperature sensors. It forwards this data to the K2 when requested, and can also signal the K2 when any monitored condition is out of range and may require a power reduction. This communication takes place across the K2's 1-wire network, the AuxBus, which is connected to pin 28 of U1. U1 also controls the fan, based on heat sink temperature, and drives the PA KEY transistor (Q9).

Unlike other AuxBus devices in the K2, which sleep during inactive periods, U1 runs continuously monitoring KPA100 sensors. For this reason, it uses a crystal oscillator rather than a ceramic resonator.

K3-K12 select low-pass filters. The drive lines from U1 are buffered by U2. Note: The 40/30 m filter can be used on 60 m; it provides some rolloff at the 2nd harmonic, 10.8 MHz. Combined with inherent PA balance, 60 m 2nd harmonic suppression is typically 50 dB.

The 18.432 MHz crystal oscillator (Q8, X1, T3, etc.) is used to derive the T-R switch bias voltage (90-150 V) as well as the (-) voltage for the RS-232 IC. D1-D8 are used for rectification and voltage doubling.

U4 is an RS-232 transceiver IC. It converts the 5V logic-level signals at pins 11 and 12 (RX/TX data) to RS-232 levels, +/- 5 to +/- 12 VDC.

P1 is the interface connector between the K2 Control board and the KPA100. The 12CTRL line (12 volts switched) is used to power the KPA100 fan, relays, HV bias supply, RS-232 interface and SWR bridge. This allows these circuits to be used and tested even if a high-current power supply is not connected at J3.

Schematic Diagrams

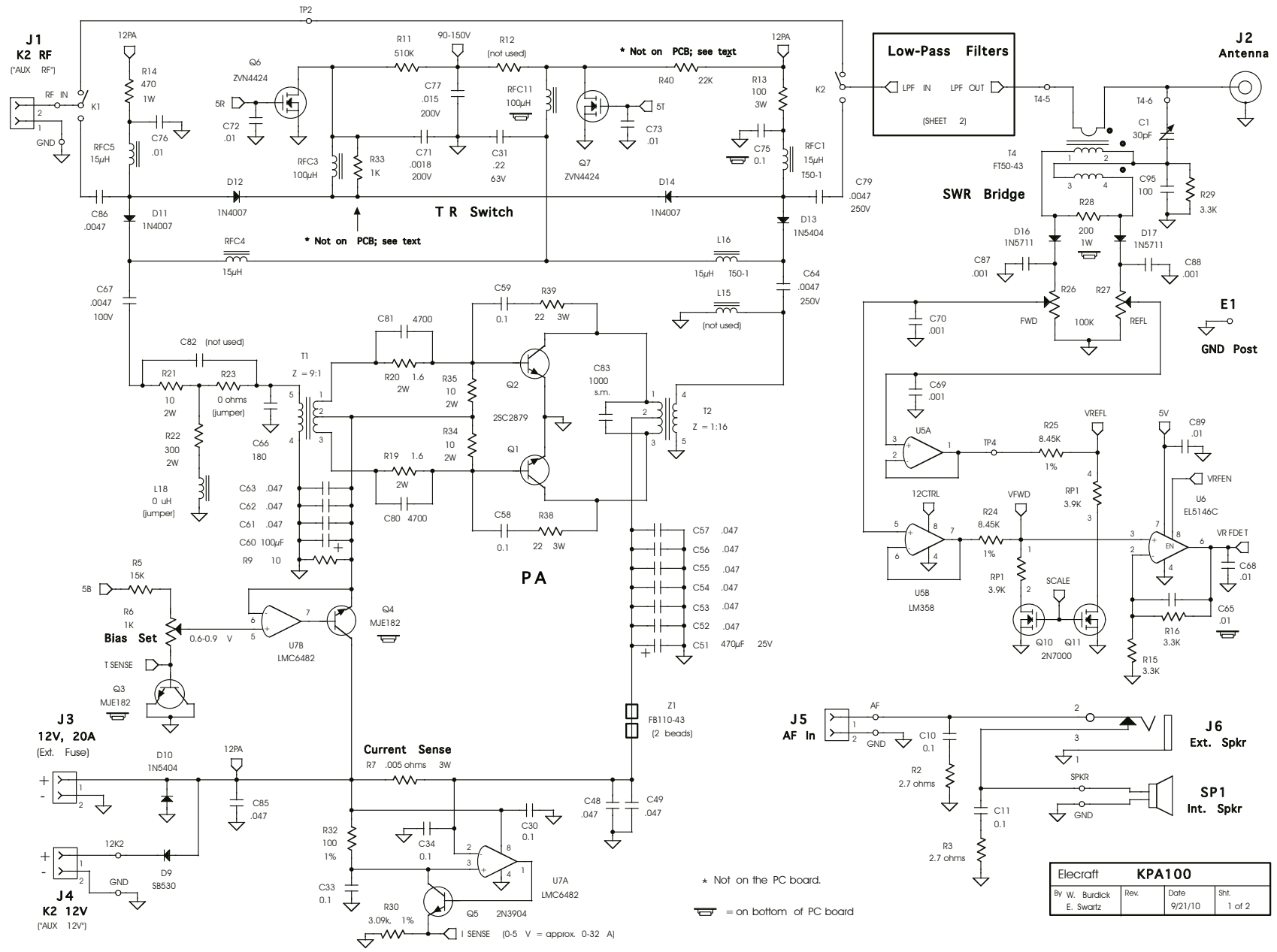

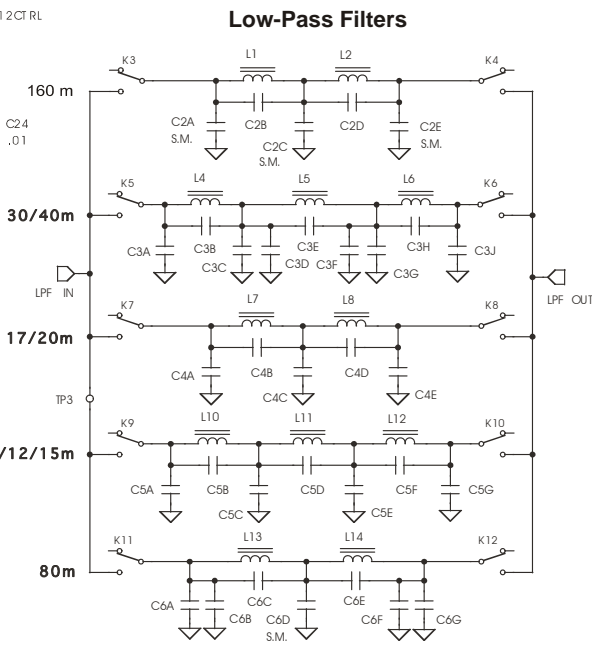
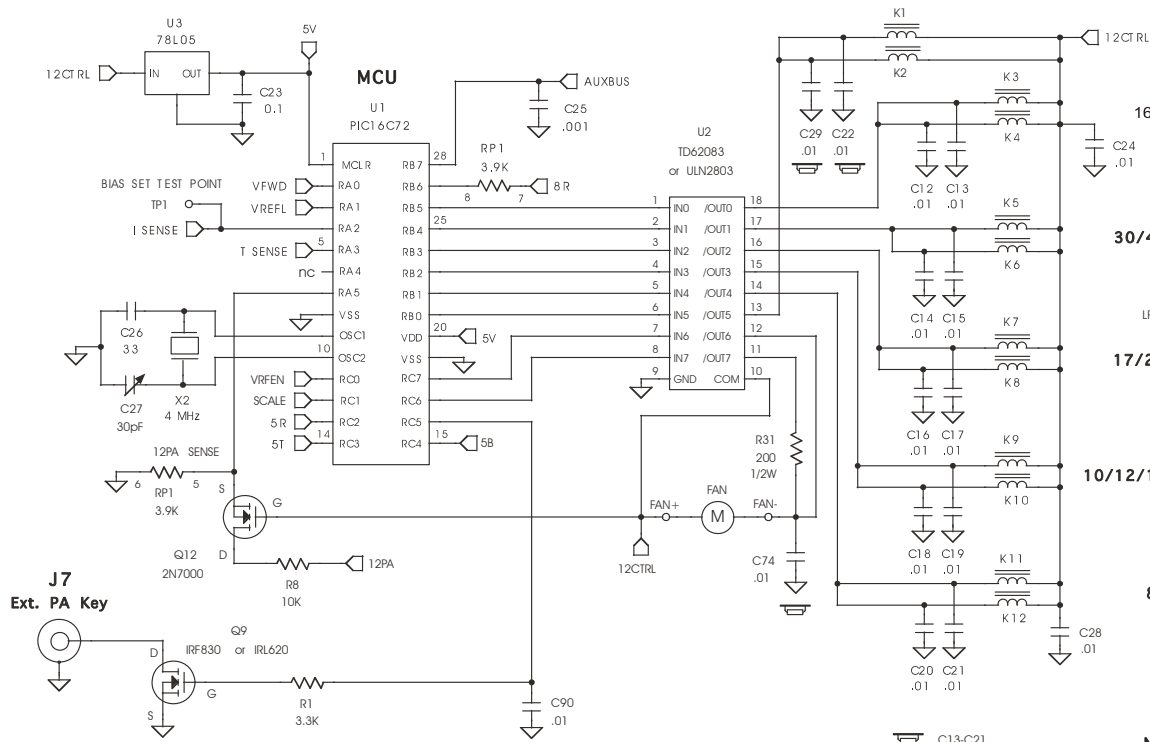

NOTES: All relays are shown in the RESET (de-energized) condition.
 = on bottom of PC board (nearest the heatsink).

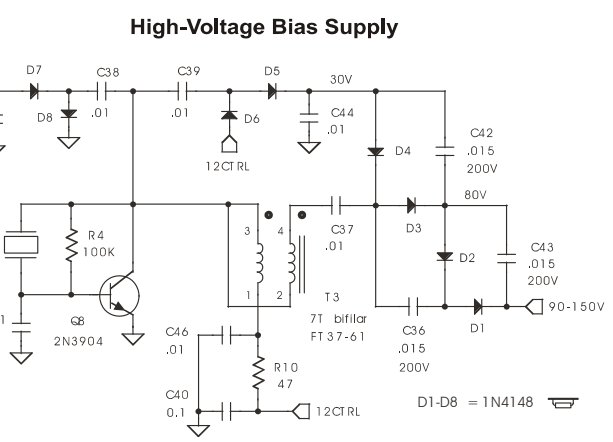
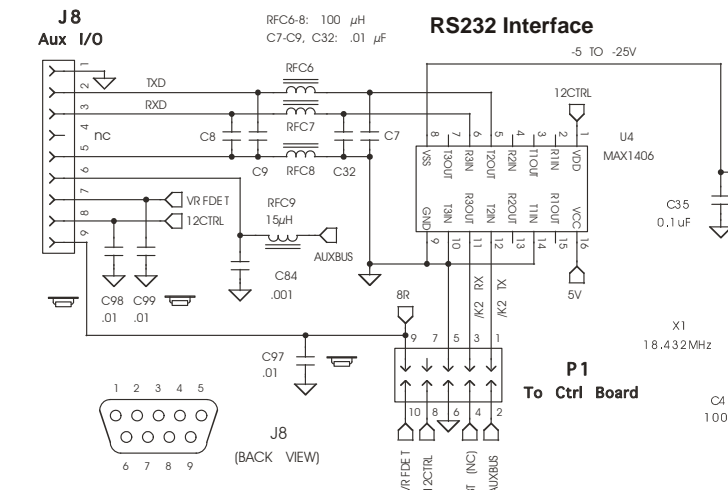

Elecsoft		KPA100	
By W. Burdick	Rev. H	Date 9/25/06	Shr. 2 of 2
E. Swartz			

Parts Placement Drawings

(Top Side)

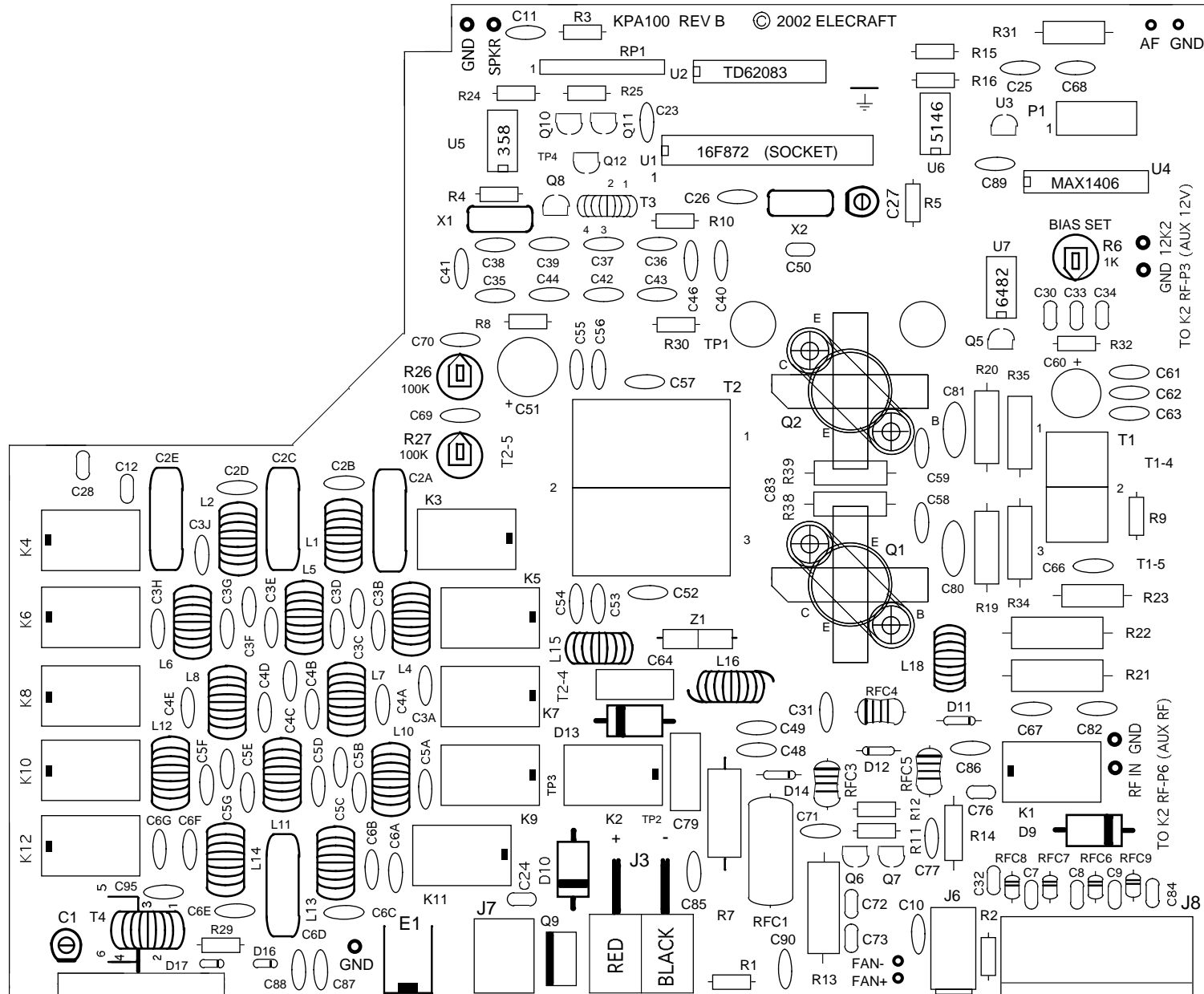

Parts Placment Drawing
(Bottom Side)

